



FABER

FRANKE'S AIR EXPERT

KOLEKCIJA 2024/2025

 **FABER**

F R A N K E ' S A I R E X P E R T

**INTEGRIRANE
NAPE U
INDUKCIJSKU
PLOČU**

STR. 20



Galileo NG 20



Galileo Stripes
20



Galileo Smart
20



Galileo Bold 21



Galileo Linear
21



Galileo 60 21

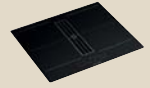

Galileo Slim 21

**INDUKCIJSKE
PLOČE**

STR. 22



FCH95 22



FCH SLIM 94 22



FCH84 22



FCH64 23



FBH64 23



FBH32 23

**NAPE - AIR
TREATMENT
TECHNOLOGY**

STR. 24



V-Air 24



T-Air 24



Bi-Air 24

**F-LIGHT
NAPE**

STR. 24



Belle Plus 24



Céline Plus 25



Soft Cube 25



Pareo Plus 25



Beat XL 25



Beat 25

**STROPNE
NAPE**

STR. 26



High-Light 26



Heaven Glass
2.0 26

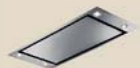

Heaven 2.0 26

**PULTNE
NAPE**

STR. 26



Fabula Plus 26

**ZIDNE NAPE
- ZERO DRIP
TEHNOLO-
GIJA**

STR. 27



Glam Light Zero
Drip Plus 27



Glam Light
Zero Drip 27

ZIDNE NAPE

STR. 27



Modular 27



Chloé 28



Chloé XL 28



Thea 28



Veil 28



Cylindra Gloss
Plus 29



Cylindra Plus
29



Cylindra 29



Eclipse 29



Beat Wall 29



Lithos 30



Soft Edge 30



Soft Slim 30



Glam-Light 30



Glam-Fit 30

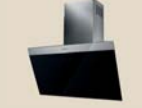

Daisy Plus 31

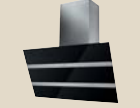

Steelmax 31



Tweet 31



VRT 31



Luft 32



Onyx-T 32



T-Light 32



T-Dark 33



Bella Silence 33



Stilo Glass
Smart 33



Stilo Comfort
33



Stilo Smart 33



Ray 34



Nice 34



TGL 34



Tender 34



Strip Smart EV8
34



Strip Smart PB
34



Value BK 35



Value SL 35

OTOČNE NAPE

STR. 35



T-shelf 35



Thea Isola 35



Corinthia Isola
36



Cylindra Isola
Plus 36



Cylindra Isola
Gloss Plus 36



Cylindra Isola
36



Cubia Isola
Gloss Plus 37



T-Light Isola 37



Bella Silence
Isola 37



Stilo Glass
Smart Isola 37



Stilo Comfort
Isola 37



Glassy Isola/
SP 38



Tratto Isola/
SP 38

KUTNE NAPE

STR. 38



Solaris 38

UGRADBENE I TELESKOPSKE NAPE

STR. 38



Ilma Touch 38



Ilma 39



Hava 39



In-Nova Zero
Drip 39



In-Nova Touch
39



In-Nova
Premium 39



Ultra Slim 40



In-Nova
Comfort 40



In-Nova Smart
40



In-Light 40



Inka Lux 3.0
Premium 41



Inka Lux 3.0
Evo 41



Inka Lux Smart
41



Inka Plus HCS
41



Inka Plus HC 41



Inka Smart HCS
42



Inka Smart HC
42



Inka Smart C
42



Maxima Touch
42



Maxima Eco 42



Flexa Glass Lux
42



Flexa Glass 43



Flexa Hip 43



Flexa 43



152 43

KLASIČNE NAPE

STR. 43



2740 PB 43



741 Base 43

PRIBOR

STR. 44

UGRADNJA

STR. 60

OBRATITE PAŽNJU

PRAVILNO MJERENJE USISNOG KAPACITETA NAPE

Podaci o izvedbi iskazani u ovom katalogu mjereni su prema novom kodeksu, koji su potpisali najkvalificiraniji europski proizvođači udruženi u CECED (Europsko udruženje proizvođača domaće i profesionalne opreme). To je strogi kodeks određen radi transparentnosti podataka kapaciteta i buke napa, mjernih pravila zajedničkih svim proizvođačima:

- sposobnost usisavanja prema IEC / EN 61591 standardu (napa s odvodom zraka)
- razina buke u skladu s IEC / EN 60704-3 standardom

PROTOK ZRAKA MOTORA

Jedan od pogrešnih načina mjerenja kapaciteta nape je mjerenje protoka zraka u motoru, bez ikakvog otpora (motor pritom nije ugrađen u napu, a time nema otpora niti filtera, niti otpora prilikom kanaliziranja zraka u izlaznu cijev).

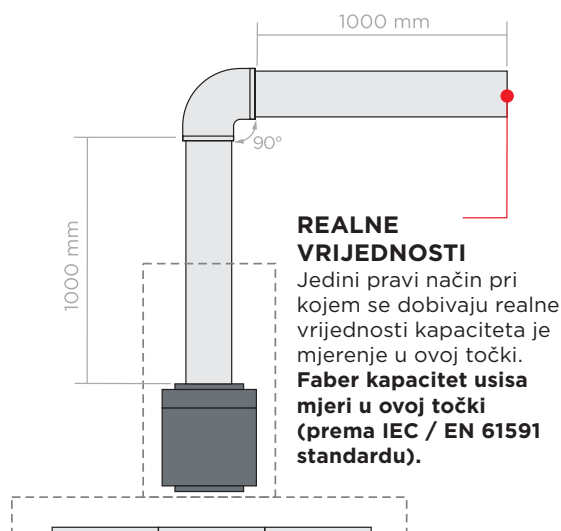
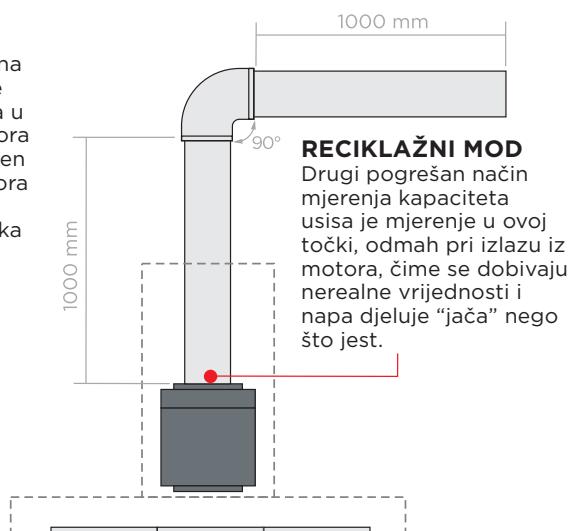

PRAVILNO MJERENJE USISNOG KAPACITETA - REALNE VRIJEDNOSTI

Usisni kapacitet mjeri se kod standardne odvodne cijevi duljine 1 dužnog metra + zavoja pod kutem 90° + 1 dužni metar, promjera 120 mm.

Metoda mjerenja prema IEC / EN 61591 standardu vjerno reproducira tipične uvjete ugradnje i uporabe i osigurava stvarne, pouzdane informacije.

Obratite pozornost na to da li napa zadovoljava ove norme - na ovaj način možete pružene informacije smatrati ispravnima i pouzdanima, kao kod Faberovih napa.

Sve informacije o tehničkim podacima i značajkama, uključujući količine masnoća koje zaustavljaju filteri i jačine osvjetljenja, mjere se u Faberovim laboratorijima, koji su ovlašteni za takva ispitivanja od strane IMQ i NEMKO.

CERTIFIKATI

IMQ

Talijanski znak kvalitete, priznat u Europskoj uniji.

SEMKO

Semko je dio Intertek ETL-a, svjetskog lidera u certifikaciji proizvoda.

UL

Američki i kanadski znak za kvalitetu.

CCC

Kineski znak za kvalitetu.

PRIJE KUPNJE

ABECEDA KUHINJSKE NAPE

Napa s odvodom zraka izbacuje mirise i izvlači paru nastalu u kuhinji. Ona predstavlja najefikasnije rješenje.

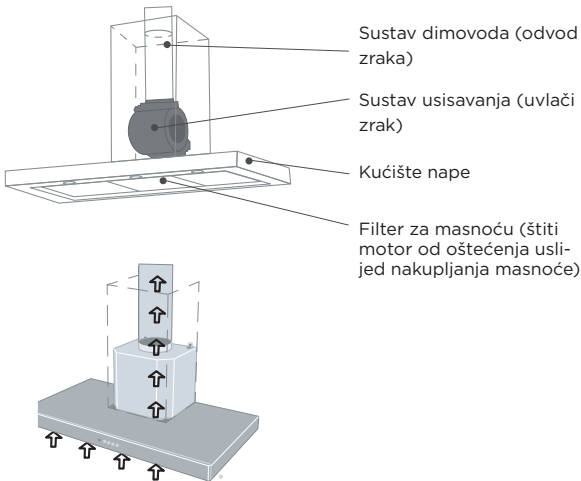

Filtracijska napa izvlači zrak, filtrira mirise i paru, a zatim u kuhinju vraća pročišćeni zrak.

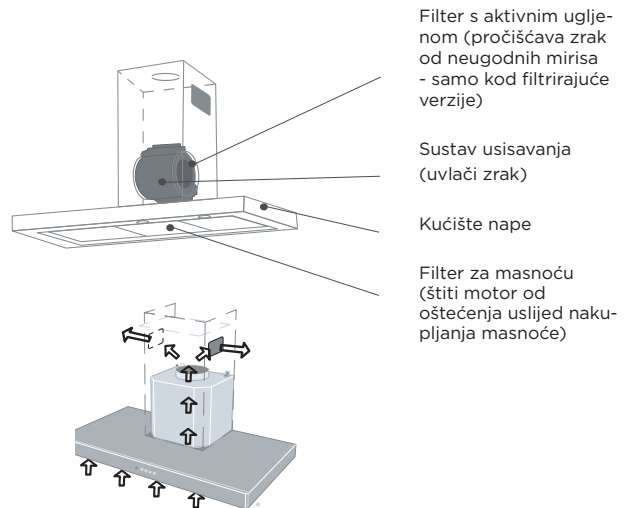

ODABERITE ODGOVARAJUĆU NAPU

Potreban kapacitet usisavanja određuje se prema veličini vaše kuhinje. Učinkovita napa radi 10 izmjena zraka po satu¹.

Jači motor je tiši i koristi manje energije jer je učinkovitiji na malim brzinama

- Ukoliko je usisni kapacitet nape dovoljan, napa ne proizvodi buku i ne prelazi jačinu zvuka iznad 55 dB(A)

-Prilagođene brzine omogućuju odabir odgovarajuće razine usisavanja zraka uz minimalnu buku.

¹ Fan Handbook - F. Bleier 1998

$$\text{UČINKOVITOST} = \frac{\text{površina kuhinje u m}^2 \times \text{visina kuhinje}}{10} \times \text{izmjena zraka}$$

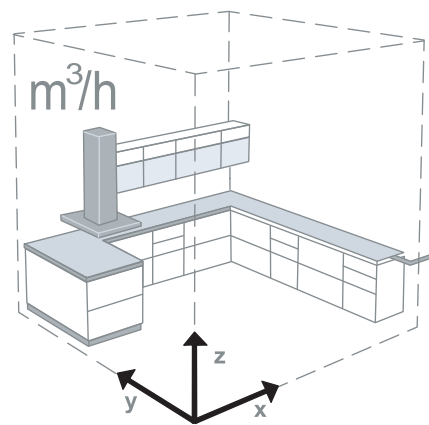

Primjer:

Kuhinja veličine 15 m², visine 3 m, zahtijeva napu usisnog kapaciteta od minimalno 450 m³/h.

Odnosno: 15 m² x 3 m x 10 = 450 m³/h.

Pogledajte tablicu priloženu u katalogu proizvoda. Kapacitet nape je odgovarajući ukoliko se u jednoj od kolona brzine nalazi jednaka ili viša vrijednost kapaciteta.

PERFORMANSE

| Brzina | 1 | 2 | 3 | MAX | INT |
|-----------------------|-----|-----|-----|-----|-----|
| Kapacitet usisa (IEC) | 220 | 365 | 420 | 645 | 880 |
| Pritisak | 410 | 430 | 435 | 510 | 610 |
| Snaga | 10 | 25 | 35 | 105 | 270 |
| Razina buke | 41 | 53 | 56 | 67 | 73 |

NAPREDNE TEHNOLOGIJE

FABER CLOUD



Ekskluzivna aplikacija Faber Cloud može se koristiti za praćenje kvalitete zraka u vašoj kuhinji i podešavanje glavnih postavki nape u bilo kojem trenutku, čak i s mobitela.

K-LINK



Uz radio vezu između nape i Faberove indukcijske ploče za kuhanje, snaga usisavanja automatski se podešava prema odabranoj razini kuhanja kako bi se optimizirale performanse i izbjegao nepotreban trošak.

UV-C LAMP

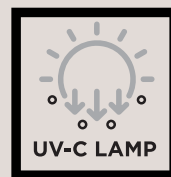

Ubija viruse i bakterije s maksimalnom sigurnošću bez stvaranja ozona.

SOUND PRO



Smanjenjem turbulencije i vrtloga u unutarnjem strujanju zraka, nova tehnologija nape uspijeva ograničiti buku i poboljšati kvalitetu zvuka nape.

AIR QUALITY SENSOR



Držite pod nadzorom temperaturu, postotak vlažnosti i prisutnost hlapljivih organskih spojeva u kućnom okruženju. Senzor automatski podešava usisnu snagu dok se ne uspostavi savršena kvaliteta zraka.

SIL & STILL



Zahvaljujući SIL & STILL tehnologiji, nape iz Still linije proizvode samo 52 dB(A) buke pri punoj snazi. Povrh toga, ako se odabere Eco funkcija, koja kombinira SIL & STILL sa motorom bez četkica (BRUSHLESS), napa prelazi u ultratih mod sa manje od 40 dB(A) buke.

STEAM OFF SYSTEM

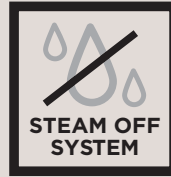

Faber potpuno eliminira kondenzaciju ispod i oko nape. Kontrolirani spiralni zračni mlazovi sa varijabilnom geometrijom stvaraju dva vrtloga koji kontroliraju unos dima i pare.

ZERO DRIP



Zaustavite kondenzaciju! Zero Drip skuplja kondenzat u okvir sprečavajući da kaplje na ploču za kuhanje. Zero Drip Plus uzrokuje isparavanje kondenzata zahvaljujući posebno zagrijanom staklu nape.

AIRLANE



Maksimalno usisavanje kroz nevidljivi prolaz. Pri uključivanju nape automatski se aktivira drugi motor u stropu. Drugi motor hvata dim i paru kako bi pročistio zrak cijelog prostora i osigurao maksimalnu udobnost.

UP & DOWN



Napa se spušta prema ploči za kuhanje kako bi se optimiziralo usisavanje, a nakon korištenja se podiže i potpuno nestaje u stropu, u potpunosti oslobađajući prostor.

NAUTILUS



Više snage, manje buke, vrhunska udobnost! Faber tehnologija povećava kapacitet usisavanja za 30 m³/h, smanjuje buku i poboljšava učinkovitost, uvijek uz minimalnu potrošnju.

ARIES



Aries tehnologija pomoću snage 2 motora bez četkica postiže kapacitet preko 700 m³/h uz manju buku (do -9 dB(A)). Vrhunska, uštedom energije i tihim performansama Aries tehnologija stavlja vertikalne nape u klasu A.

BRUSHLESS



Motor bez četkica osigurava značajnu uštedu energije u kombinaciji s visokom učinkovitosti ekstrakcije. To je najtiši motor na tržištu, a njegova svojstva ostaju jednaka u svim uvjetima korištenja.

WATERPROOF



Svaka tekućina prolivena tijekom kuhanja ulijeva se izravno u usisnu rešetku i sakuplja se automatski u odvodnu pliticu ispod nape, dovoljno malu da ostane mjesto za ladicu za posude.

POWER MANAGEMENT



Postavka apsorpcije podesiva je na 4 razine snage (kW). Nema više prekida napajanja uslijed preopterećenja!

REAR OUTLET



Omogućuje odvod pare i mirisa u otvor iza same nape umjesto iznad. To eliminira potrebu za gornjim odvodom i oslobađa prostor iznad nape.

IZDVOJEN MOTOR



Mogućnost ugradnje motora dalje od nape, daje veću slobodu pri dizajniranju napa te smanjuje buku u kuhinji.

OBODNI USIS

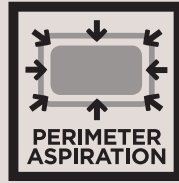

Smanjuje doživljenu buku za 25% (*). Visokorazvijeni sustav obodnog usisavanja po principu Venturijevog efekta: zrak ubrzava kako se približava i prolazi kroz suženi prostor usisa, nakon čega unutar nape odmah usporava i lako se izbacuje bez potrebe za posebno jakim pritiskom. (*) Odgovara smanjenju buke od 3 dB (A) sukladno normi EN 60704-3

HFH FILTERING



HFH: visoko učinkovit, ekskluzivni Faberov sustav filtriranja aktivnim ugljenom, koji u usporedbi s tradicionalnim ugljenim filterom poboljšava eliminacije neugodnih mirisa (95%).

FILTER ALARM



Upozorenje zasićenja filtera: upozorava korisnika kada je potrebno očistiti filter masnoće ili zamijeniti filter mirisa.

SELF START



Posebni senzor uključuje napu čim temperatura zraka dosegne 35°C. Pametni senzor koji omogućuje samoaktivirajuće pokretanje kuhinjske nape, samo kada je to potrebno. Tako je omogućeno optimalno iskorištenje usisa nape i olakšan rad u kuhinji.

AUTOMATSKA FUNKCIJA

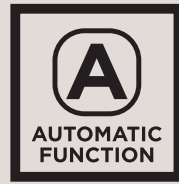

Napa se automatski uključuje najprikladnijom brzinom, prilagođavajući kapacitet usisa maksimalnoj razini kuhanja.

HOUR 24

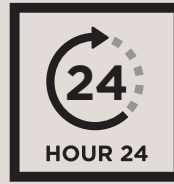

Tipka 24: pokretanjem ove funkcije napa radi 24 sata dnevno, radi konstantne izmjene zraka u prostoru, uz potpuno bešuman rad.

DELAY 30



Odgodeno gašenje nape: omogućuje odgodu prestanka rada nape kako bi izvukla zaostale mirise i pare nakon prestanka kuhanja.

SPEED I



Intenzivan rad (brzina): funkcija koja aktivira maksimalan kapacitet izvlačenja zraka na 6 minuta, nakon čega se vraća na zadnju podešenu brzinu.

BOOST



Ova dodatna snaga motora nape ima mogućnost da usiše i najmanji ostatak pare i mirisa u par minuta.

LED LIGHT

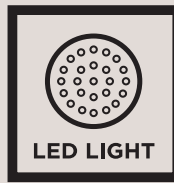

Zahvaljujući LED rasvjeti imat ćete odlično osvjjetljenje i izvrsnu vidljivost na cijelom području kuhanja, uz znatnu uštedu energije.

LED LIGHT DIMMER



Svjetlo koje se može prigušiti: pritiskom na tipku svjetlo se priguši i može ostati dugo uključeno uz minimalnu potrošnju energije.

TUNABLE WHITE



Na nekim modelima možete odabrati i mijenjati temperaturu boje svjetlosti, od toplije (prema žutoj) do hladnije (prema bijeloj).

SOFT TOUCH



FENIX®, visokotehnološki materijal s jedinstvenim karakteristikama. Mekan i gladak na dodir, satiniran i otporan na mrlje.

ANTI TOUCH



Inox bez otisaka prstiju za savršeno čistu napu i površinu bez dosadnih nečistoća.

TOUCH CONTROL



Iznimno ugodne Touch Slider kontrole jednostavne za uporabu.

REMOTE CONTROL



Novi daljinski upravljač kompatibilan je s mnogim Faberovim napama. Za podešavanje usisavanja i posebnih funkcija, kao što su prigušeno svjetlo, značajke 24H, Up&Down i Steam Off. Upravljanje napom je lakše no ikad.



MEĐUSOBNI DIJALOG PLOČE ZA KUHANJE I NAPE

Faber je stvorio inteligentnu vezu između ploče za kuhanje i nape, putem integriranog sustava koji radi radiovalovima. Dovoljno je postaviti napu na automatski rad. Sustav je uvijek aktivan jer se radio signal nikada ne prekida.



K-LINK TEHNOLOGIJA I NAPA SE AUTOMATSKI PRILAGOĐAVA JAČINI PLOČE ZA KUHANJE

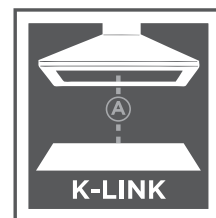

SLOBODNE RUKE U KUHINJI

Ljepota kuhanja također je u tome što se možete slobodno izražavati, bez ometanja. Ako imate Faber indukcijsku ploču za kuhanje i Faber kuhinjsku napu s K-LINK priključkom, samo počnite kuhati i snaga usisavanja nape automatski se prilagođava odabranoj razini kuhanja.





DINAMIČKA OPTIMIZACIJA FLUIDA

Zahvaljujući inovativnom dizajnu, novi motor značajno smanjuje turbulenciju i vrtlog unutarnjeg strujanja zraka.

SOUND PRO

TIHO! VRIJEME JE ZA KUHANJE

SMANJENJE BUKE I OPTIMIZACIJA KVALITETE ZVUKA

Pri najvećoj snazi, nova tehnologija ograničava prag buke nape do -6db*.

Također optimizira proizvedeni zvuk, smanjujući smetnje uzrokovane visokim frekvencijama.

Dostupan u nekoliko modela Faber napa, provjerite ikonu pored pojedinog proizvoda.

*Podaci se razlikuju ovisno o modelu u koji je puhalo ugrađeno.



- ▶ OPTIMIZACIJA DINAMIKE FLUIDA
- ▶ SMANJENJE BUKE
- ▶ OPTIMIZACIJA KVALITETE ZVUKA

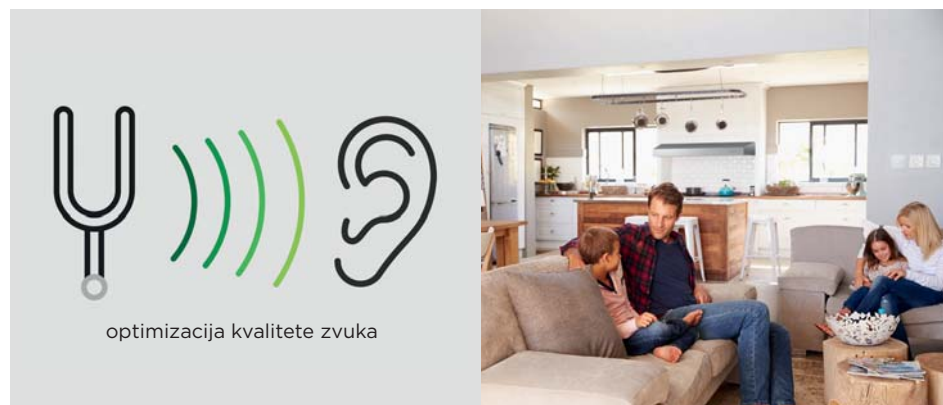

FABER UKLANJA PROBLEM KONDENZACIJE

Uklanjanje kondenzacije ključno je za zaštitu zidnog kuhinjskog elementa na koji je postavljena napa i kako bi se spriječilo kapanje vlage po ploči za kuhanje. Faber je uspio stvoriti posebne potpuno učinkovite antikondenzacijske sustave.

KONDENZACIJA VIŠE NIJE PROBLEM

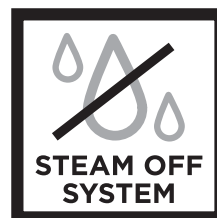

STEAM OFF SYSTEM

Steam Off System s ekskluzivnom Faberovom tehnologijom uklanja problem od početka, izbjegavajući stvaranje kondenzacije.

Tijekom usisavanja, napa emitira kontrolirane mlazove zraka koji vrtloženjem i ubrzanjem pospješuju kretanje prema gore i prenose pare kako bi ih sve obuhvatili.

ZERO DRIP

Zaustavite kondenzaciju!

Zero Drip skuplja kondenzat u okvir sprečavajući da kaplje na ploču za kuhanje.

Zero Drip Plus uzrokuje isparavanje kondenzata zahvaljujući posebno zagrijanom staklu nape.



Luft



Ilma Touch



Ilma



Hava



Glam Light
Zero Drip Plus



Glam Light
Zero Drip



In-Nova Zero
Drip



Faberov asortiman Soft sastoji se od viseće nape F-light (Soft Cube) i dvije okomite nape montirane na zid (Soft Edge i Soft Slim). Sve su dostupne s tri završne FENIX® obrade: Grigio Londra, Bianco Kos i Nero Ingo.

ASORTIMAN SOFT REVOLUCIONIRA DIZAJN

Faberov asortiman napa Soft izrađen od visokotehnološkog materijala FENIX® s jedinstvenim karakteristikama.

Matirana površina, otporna na mrlje, mekana je na dodir i reflektira vrlo malo svjetlosti. Svojom neporoznošću olakšava svakodnevno održavanje i čišćenje.

FENIX® je materijal s velikom otpornošću na ogrebotine, abrazije, suhu toplinu i kiseline. Njegova ga svojstva čine savršenim za kuhinje.

Jedna od korisnih značajki je mogućnost samostalnog ispravljanja površinskih mikroogrebotina.



SOFT TOUCH

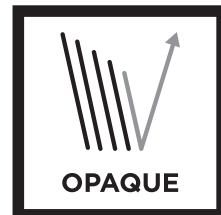

OPAQUE



ANTITOUCH



SOFT CUBE



SOFT EDGE



SOFT SLIM

IZBACIVANJE
IZ KUĆNOG
OKRUŽENJA

4

VRHUNSKO
PROČIŠĆAVANJE
ZAHVALJUJUĆI
GORNJEM
MOTORU

3

STVARANJE
UZLAZNOG
ZRAČNOG
VRTLOGA

2

ODVODNJA
DIMA I PARE
OD KUHANJA

1



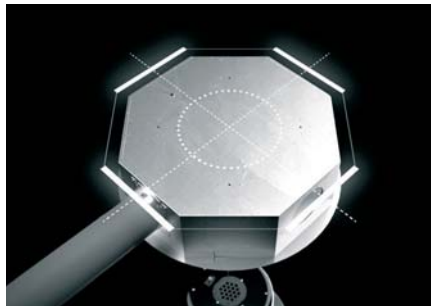

Airlane krije drugi motor u samo 30 cm spuštenog stropa što vam omogućuje da tijekom ugradnje odaberete između četiri položaja za izlaz zraka.

KIT AIRLANE TEHNOLOGIJA

KIT AIRLANE FUN 112.0542.875

KARAKTERISTIKE

Završna obrada / boja

• Nehrđajući čelik

Ø promjer odvoda

150 mm

Širina

840 mm

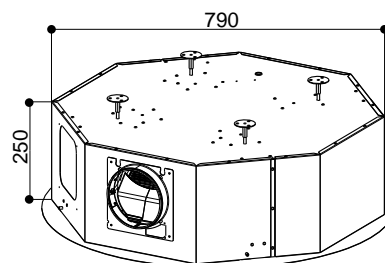
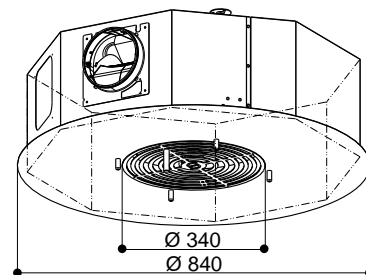

AIRLANE KIT ZAMJENJUJE DIMNJAK/DIMOVD POTREBAN ZA VISEĆU UGRADNJU NAPE.

NOVI PLUS ZA F-LIGHT NAPE.

Pomoću sljedećih F-Light napa, fiksnih i onih s pomicanjem gore-dolje, napokon se možete riješiti usisne cijevi. Potpuno nestaje zahvaljujući AIRLANE tehnologiji koja također jamči bolje pročišćavanje zraka i performanse energetske klase A.



BELLE PLUS



CĚLINE PLUS

Opcija na svim F-LIGHT modelima



AIR TREATMENT

AIR TREATMENT

KVALITETA ZRAKA UVIJEK JE POD KONTROLOM

NAPE POVEZANE S VAŠIM SVIJETOM

Sve nape u Faberovom programu AIR TREATMENT imaju senzor za kvalitetu zraka. Taj inovativni instrument nadzire zrak i aktivira usisavanje ako otkrije prisutnost alergena, onečišćujućih tvari ili mirisa.

Pohranjivanjem podataka u Faber Cloud putem aplikacije koju možete preuzeti na pametne telefone možete u bilo kojem trenutku, čak i na daljinu, nadgledati kvalitetu zraka kod kuće.





MOGUĆNOST DALJINSKOG UPRAVLJANJA

IDEALNO RJEŠENJE ZA VAŠ PAMETNI DOM.

Ekskluzivna aplikacija dizajnirana je za praćenje kvalitete zraka u vašoj kuhinji i daljinsko upravljanje napom, uz jednostavne i intuitivne funkcije.



ASORTIMAN KOJI JE UVIJEK POVEZAN

Faberov AIR TREATMENT je cjeloviti asortiman koji se sastoji od vertikalnih, stropnih, ugradbenih i napa T-oblika. Sve te nape imaju senzor kvalitete zraka, povezivanje na Faber Cloud i omogućuju daljinsko upravljanje putem aplikacije. Uz to, model K-air dolazi opremljen ekskluzivnim integriranim monitorom od 21,5 inča.



V-AIR



T-AIR



BI-AIR

GALILEO.

Jednostavno genijalno.



DJELOTVORAN.

Pametnim fluidno-dinamičkim dizajnom Galileo se ističe visokim kapacitetom usisa do 6,6 metara u sekundi. Ima moć eliminirati veliku količinu pare i mirisa u samo nekoliko minuta.



JEDNOSTAVNA ZA UPORABU I ODRŽAVANJE.

Površina ploče za kuhanje je glatka i bešavna što omogućuje brzo i jednostavno uklanjanje prljavštine.



UŠTEDA PROSTORA.

U ormarić ispod Galileea moguće je ugraditi skrivenu ladicu u koju možete lako spremi posuđe za kuhanje.

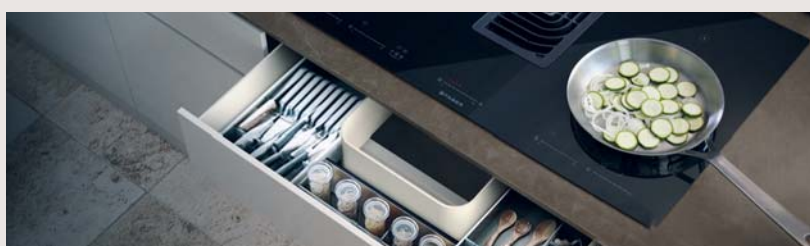

VISOKA UČINKOVITOST.

Vrhunac estetskog savršenstva s integracijom ploče za kuhanje i nape u jedan proizvod za izvanredne performanse.

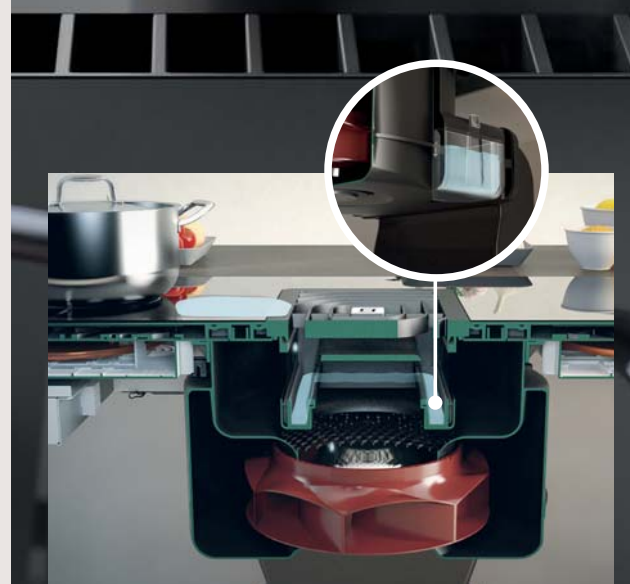



TOUCHSLIDER

ERGONOMSKI.

Prikladne i za korisnika jednostavne klizne "touch" kontrole omogućuju vam jednostavno podešavanje zona kuhanja i razine usisa.

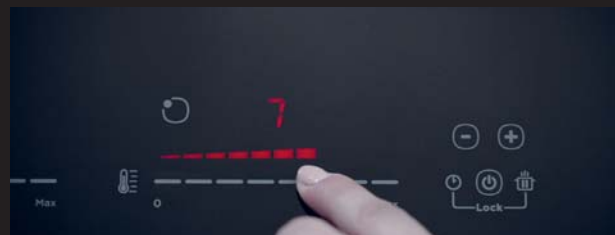

BRIDGE ZONE

OSLOBODITE SVOJU KREATIVNOST.

Zone za kuhanje mogu se aktivirati u kombiniranom načinu rada kako bi se koristile zajedno s istom razinom snage, idealno za kuhanje hrane u velikim posudama.



KORISTAN.

Filtar za mast je izuzetno učinkovit, a ujedno je i funkcionalan jer djeluje kao prva prepreka i može prikupiti do 0,5 litara tekućine. Jednostavno se uklanja i može prati u perilici posuđa.



WATERPROOF

MAKSIMALNA SIGURNOST U KUHINJI.

Vodootporna tehnologija jamči ispravno funkcioniranje i sigurnost čak i u slučaju izlivanja tekućina na ploču za kuhanje. Ne ometaju kuhanje i sakupljaju se u posebnom odjeljku ispod nape.

INTEGRIRANE NAPE U INDUKCIJSKU PLOČU

GALILEO NG

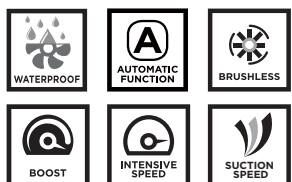

M³/H BOOST 700 RAZINA BUKE dB(A) BOOST 72

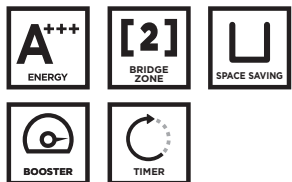

W 7400 ↔ 830x520 mm

FUN: 340.0594.624
Crno staklo/
lijevano željezo



GALILEO STRIPES



FUN: 340.0708.968
Crno staklo/Dizajnerska rešetka sa ukrasom od nehrđ. čelika Ekstrakcijska

FUN: 340.0708.969
Crno staklo/Dizajnerska rešetka sa ukrasom od nehrđ. čelika Filtracijska

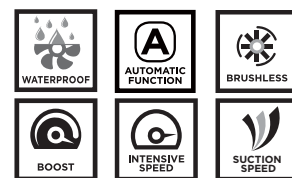

M³/H BOOST 600 RAZINA BUKE dB(A) BOOST 72

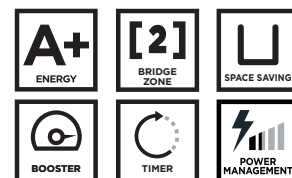

W 7400 ↔ 830x520 mm

GALILEO SMART

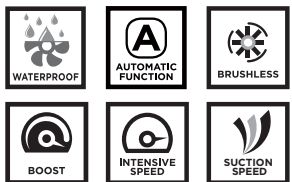

M³/H BOOST 700 RAZINA BUKE dB(A) BOOST 72



W 7400 ↔ 830x520 mm

FUN: 340.0577.694
Crno staklo/
lijevano željezo



Galileo se ističe zbog svoje vodootporne tehnologije motora, koja jamči normalno funkcioniranje i potpunu sigurnost čak i kad se na ploči za kuhanje prolije velika količina tekućine.



Kompaktni dizajn motora znači da je Galileo jedini proizvod u svojoj klasi koji ostavlja dovoljno slobodnog prostora unutar ormarića kako bi se ladica postavila odmah ispod ploče.

INTEGRIRANE NAPE U INDUKCIJSKU PLOČU



GALILEO BOLD



FUN: 340.0708.971
Crno staklo/Dizajnerska rešetka od nehrđajućeg čelika
Filtracijska

FUN: 340.0708.973
Crno staklo/Dizajnerska rešetka od nehrđajućeg čelika
Ekstrakcijska

| | | |
|-----------------|----------------------------------|-----------------------------------|
| WATERPROOF | AUTOMATIC FUNCTION | BRUSHLESS |
| BOOST | INTENSIVE SPEED | SUCTION SPEED |
| CHARCOAL FILTER | M³/H BOOST 630 | RAZINA BUKE dB(A) BOOST 73 |
| A+ ENERGY | [2] BRIDGE ZONE | U SPACE SAVING |
| BOOSTER | TIMER | POWER MANAGEMENT |
| W 7400 | 830x520 mm | |

GALILEO LINEAR



FUN: 340.0708.970
Crno staklo/Dizajnerska crna rešetka
Filtracijska

FUN: 340.0708.972
Crno staklo/Dizajnerska crna rešetka
Ekstrakcijska

| | | |
|----------------------------------|-----------------------------------|------------------|
| WATERPROOF | AUTOMATIC FUNCTION | BRUSHLESS |
| BOOST | INTENSIVE SPEED | CHARCOAL FILTER |
| M³/H BOOST 600 | RAZINA BUKE dB(A) BOOST 72 | |
| A+ ENERGY | [2] BRIDGE ZONE | U SPACE SAVING |
| BOOSTER | TIMER | POWER MANAGEMENT |
| W 7400 | 830x520 mm | |

GALILEO 60



FUN: 340.0627.227
Crno staklo/
čelična rešetka

| | | |
|----------------------------------|-----------------------------------|------------------|
| WATERPROOF | AUTOMATIC FUNCTION | BRUSHLESS |
| BOOST | INTENSIVE SPEED | |
| M³/H BOOST 630 | RAZINA BUKE dB(A) BOOST 71 | |
| A++ ENERGY | [2] BRIDGE ZONE | U SPACE SAVING |
| BOOSTER | TIMER | POWER MANAGEMENT |
| W 7400 | 600x520 mm | |

GALILEO SLIM



FUN: 340.0708.974
Crno staklo/Dizajnerska crna rešetka
Filtracijska

FUN: 340.0708.975
Crno staklo/Dizajnerska crna rešetka
Ekstrakcijska

| | | |
|----------------------------------|-----------------------------------|------------------|
| WATERPROOF | AUTOMATIC FUNCTION | BRUSHLESS |
| BOOST | INTENSIVE SPEED | CHARCOAL FILTER |
| M³/H BOOST 630 | RAZINA BUKE dB(A) BOOST 73 | |
| A+ ENERGY | [2] BRIDGE ZONE | U SPACE SAVING |
| BOOSTER | TIMER | POWER MANAGEMENT |
| W 7400 | 600x520 mm | |

DEKORATIVNA REŠETKA GALILEO SLIM



Galileo Slim uvijek se isporučuje s crnom rešetkom kao standard.
Postoji mogućnost prilagodbe odabirom jedne od pet elegantnih rešetki u boji.

- 1 FUN:** 112.0717.358 Dekorativna rešetka Galileo Slim tamno siva mat
- 2 FUN:** 112.0717.359 Dekorativna rešetka Galileo Slim titan mat
- 3 FUN:** 112.0717.374 Dekorativna rešetka Galileo Slim aluminij mat
- 4 FUN:** 112.0717.360 Dekorativna rešetka Galileo Slim prašnjavo plava mat
- 5 FUN:** 112.0717.361 Dekorativna rešetka Galileo Slim prašnjavo zelena mat

INDUKCIJSKE PLOČE ZA KUHANJE

INDUKCIJSKA PLOČA FCH95



FUN: 108.0604.943
Crno staklo



HOOD&HOB



W 7400

↔ 900x520 mm



INDUKCIJSKA PLOČA FCH SLIM 94



FUN: 108.0604.942
Crno staklo



HOOD&HOB



W 7400

↔ 900x410 mm

INDUKCIJSKA PLOČA FCH84



FUN: 108.0604.935
Crno staklo



HOOD&HOB



W 7400

↔ 780x520 mm



INDUKCIJSKE PLOČE ZA KUHANJE



INDUKCIJSKA PLOČA FCH64



FUN: 108.0604.933
Crno staklo



HOOD&HOB



W 7400

↔ 580x520 mm

INDUKCIJSKA PLOČA FBH64



FUN: 108.0604.932
Crno staklo



W 7400

↔ 580x520 mm



INDUKCIJSKA PLOČA FBH32



FUN: 108.0604.931
Crno staklo



W 3700

↔ 290x520 mm



*isključivo po narudžbi

**do isteka zaliha

NAPE - AIR TREATMENT TECHNOLOGY

V-AIR*

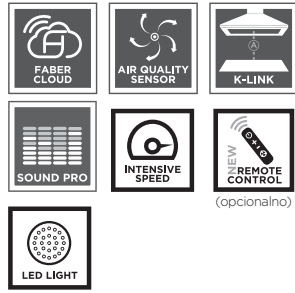

A+
ENERGY

RAZINA BUKE dB(A) INT 68

M³/H INT 770

↔ 800 mm

FUN: 330.0615.685
Crno i svijetlo smeđe staklo*



T-AIR*

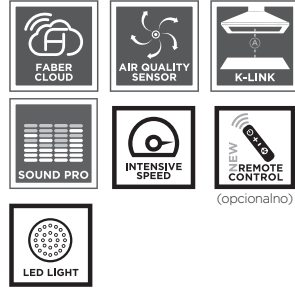

A+
ENERGY

RAZINA BUKE dB(A) INT 69

M³/H INT 750

↔ 900 mm

FUN: 325.0615.702
Crno i svijetlo smeđe staklo*

BI-AIR*



A 700 mm

RAZINA BUKE dB(A) INT 68 (700 mm)

B 520 mm

RAZINA BUKE dB(A) INT 69 (520 mm)

M³/H INT 670 (520 mm) ↔ 520 mm

720 (700 mm) ↔ 700 mm

FUN: 305.0615.686
Crno i svijetlo smeđe staklo 520 mm*

FUN: 305.0615.687
Crno i svijetlo smeđe staklo 700 mm*

F-LIGHT NAPE



BELLE PLUS*

Izvedba s AIRLINE tehnologijom

Filtracijska izvedba

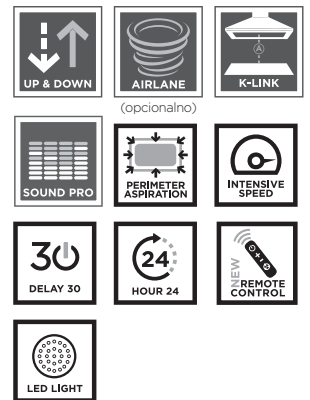

A
ENERGY

RAZINA BUKE dB(A) INT 65

M³/H INT 620

↔ 695 mm

FUN: 345.0541.068
Zlatna/topla tamno siva mat*

F-LIGHT NAPE

CÈLINE PLUS*

Izvedba s AIRLINE tehnologijom

Filtracijska izvedba



FUN: 345.0541.064
Topla bijela/
country siva mat*



SOFT CUBE*



FUN: 345.0607.590
Crna - FENIX Nero Ingo*

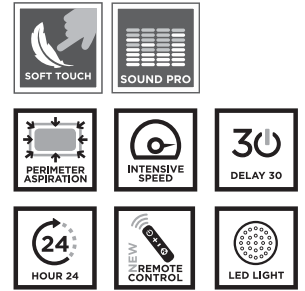

PAREO PLUS*



FUN: 345.0492.593
Nehrdajući čelik*

FUN: 345.0492.594
Tibetansko srebrna*

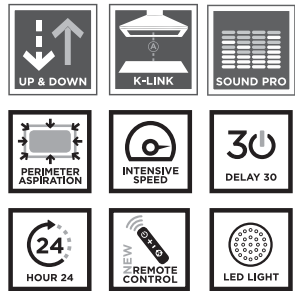

BEAT XL



FUN: 345.0698.955
Crna mat

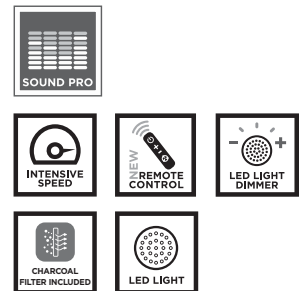

BEAT



FUN: 345.0655.177
Nehrdajući čelik

FUN: 345.0657.025 Crna sjajna **FUN:** 345.0612.337 Crna mat

FUN: 345.0612.338 Bijela mat **FUN:** 345.0612.339 Tamno siva mat

FUN: 345.0612.340 Prašnjavo plava mat **FUN:** 345.0655.178 Titan mat

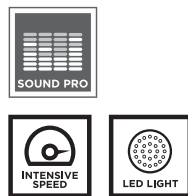

*isključivo po narudžbi

**do isteka zaliha

***uskoro u prodaji

STROPNE NAPE

HIGH-LIGHT*



FUN: 350.0663.964
Bijela mat
910 mm*

FUN: 350.0663.963
Crna mat
910 mm*

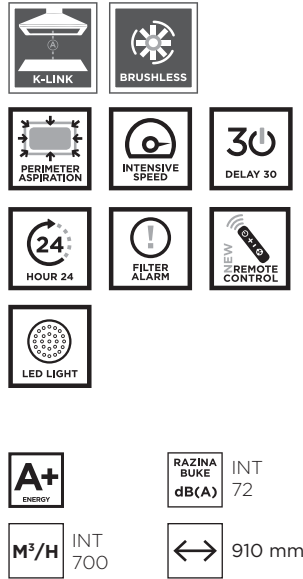

HEAVEN GLASS 2.0



FUN: 350.0621.946
Bijelo staklo K-LINK 900 mm

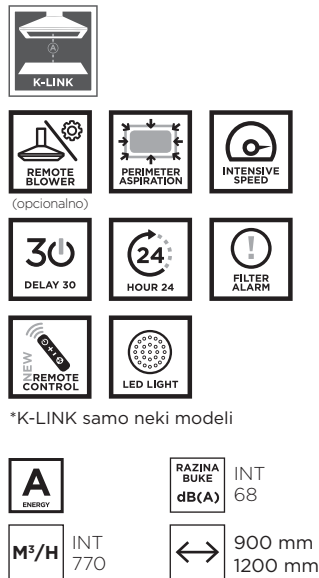

*K-LINK samo neki modeli

HEAVEN 2.0



FUN: 110.0315.792
Nehrdajući čelik 900 mm

FUN: 350.0621.950
Nehrdajući čelik K-LINK 900 mm

FUN: 110.0315.794
Nehrdajući čelik 1200 mm*



*K-LINK samo neki modeli

PULTNE NAPE



FABULA PLUS



FUN: 340.0492.566
Nehrdajući čelik/crno staklo

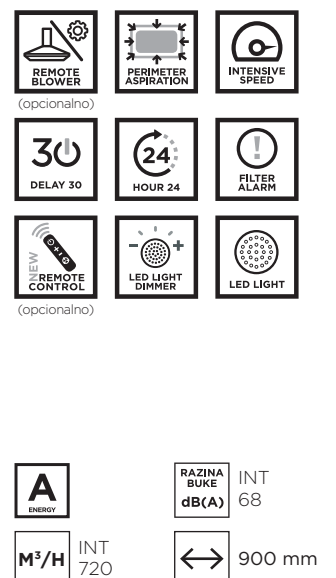

ZIDNE NAPE - ZERO DRIP TECHNOLOGY



ZERO DRIP

Zaustavite kondenzaciju!

Zero Drip skuplja kondenzat u okvir sprečavajući da kaplje na ploču za kuhanje. Zero Drip Plus uzrokuje isparavanje kondenzata zahvaljujući posebno zagrijanom staklu nape.

GLAM LIGHT ZERO DRIP PLUS



FUN: 330.0615.735
Mat crno staklo

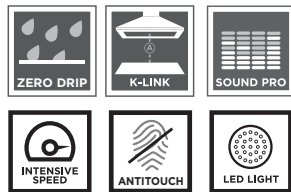

A ENERGY
RAZINA BUKE dB(A) INT 68
M³/H INT 740
↔ 800 mm

GLAM LIGHT ZERO DRIP



FUN: 330.0615.676
Crno staklo

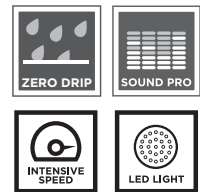

B ENERGY
RAZINA BUKE dB(A) INT 67
M³/H INT 750
↔ 800 mm

ZIDNE NAPE - DIZAJNERSKE

MODULAR



FUN: 335.0706.645
Crna mat

FUN: 112.0706.647
Polica Module crna mat

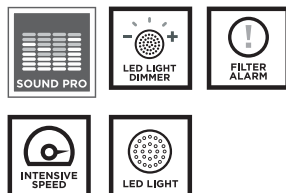

A ENERGY
RAZINA BUKE dB(A) INT 68
M³/H INT 720
↔ 600 mm



ZIDNE NAPE - DIZAJNERSKE

CHLOÈ



- FUN:** 110.0456.129 Stari metal
FUN: 110.0456.174 Stari bakar*
FUN: 110.0456.175 Lijevano željezo*
- FUN:** 110.0456.177 Stari mesing
FUN: 110.0458.989 Tamno siva mat
FUN: 110.0459.033 "Country" siva mat

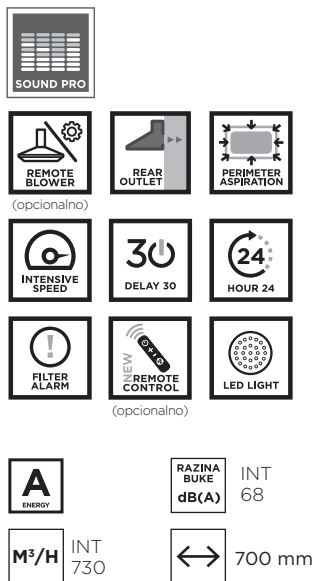

CHLOÈ XL*



- FUN:** 321.0506.536 Lijevano željezo*
FUN: 321.0506.535 "Country" siva mat*

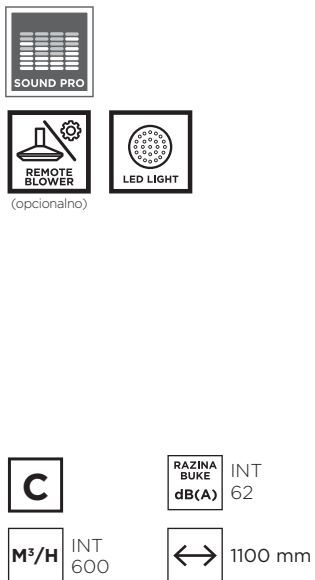

THEA



- FUN:** 321.0517.783 Bijela mat
FUN: 321.0517.784 Tamno siva mat
- FUN:** 112.0516.433 Kit inox okvir
FUN: 112.0516.434 Kit drv. hrast okvir

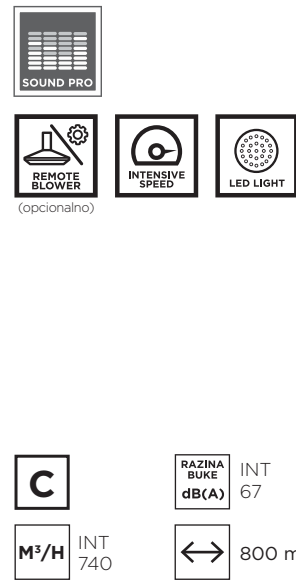

VEIL



- FUN:** 110.0324.953 Bijela*
FUN: 110.0324.954 Crna mat

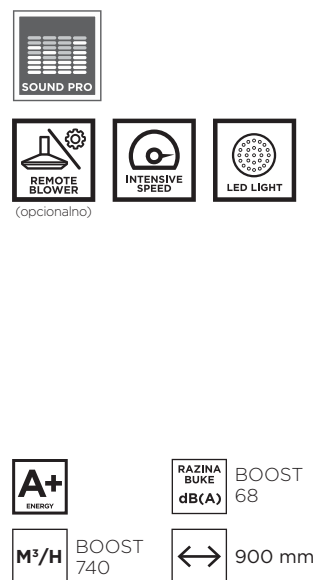

ZIDNE NAPE - DIZAJNERSKE

CYLINDRA GLOSS PLUS



FUN: 335.0492.565
Bijela sjajna

- SOUND PRO
- REMOTE BLOWER (opcionally)
- REAR OUTLET
- PERIMETER ASPIRATION
- INTENSIVE SPEED
- FILTER ALARM
- NEW REMOTE CONTROL (opcionally)
- LED LIGHT
- ENERGY CLASS: A
- RAZINA BUKE dB(A) INT 68
- M³/H INT 700
- Width: 370 mm

CYLINDRA PLUS



FUN: 335.0606.998
Crna mat

- SOUND PRO
- REMOTE BLOWER (opcionally)
- REAR OUTLET
- PERIMETER ASPIRATION
- INTENSIVE SPEED
- FILTER ALARM
- NEW REMOTE CONTROL (opcionally)
- LED LIGHT
- ENERGY CLASS: A
- RAZINA BUKE dB(A) INT 69
- M³/H INT 700
- Width: 370 mm

CYLINDRA



FUN: 110.0332.307
Nehrdajući čelik

- SOUND PRO
- REMOTE BLOWER (opcionally)
- REAR OUTLET
- PERIMETER ASPIRATION
- INTENSIVE SPEED
- FILTER ALARM
- NEW REMOTE CONTROL (opcionally)
- LED LIGHT
- ENERGY CLASS: C
- RAZINA BUKE dB(A) INT 68
- M³/H INT 660
- Width: 370 mm

ECLIPSE



FUN: 335.0538.983
Nehrdajući čelik

- SOUND PRO
- REMOTE BLOWER (opcionally)
- REAR OUTLET
- INTENSIVE SPEED
- LED LIGHT
- ENERGY CLASS: C
- RAZINA BUKE dB(A) INT 70
- M³/H INT 620
- Width: 370 mm



BEAT WALL



FUN: 335.0689.673
Mat crna

- SOUND PRO
- INTENSIVE SPEED
- CHARCOAL FILTER INCLUDED
- LED LIGHT
- ENERGY CLASS: B
- RAZINA BUKE dB(A) INT 70
- M³/H INT 740
- Width: 478 mm

*isključivo po narudžbi

**do isteka zaliha

ZIDNE NAPE - DIZAJNERSKE

LITHOS



FUN: 335.0533.565
Bijela

FUN: 335.0533.564 Bijela mat
FUN: 335.0533.563 Crna



RAZINA BUKE
dB(A) INT 61

M³/H INT 580

↔ 450 mm



SOFT EDGE

ZIDNE NAPE - VERTIKALNE

SOFT EDGE



FUN: 330.0597.526
Crna - FENIX
Nero Ingo

FUN: 330.0597.527 Siva - FENIX
Grigio Londra*
FUN: 330.0597.528 Bijela - FENIX
Bianco Kos*



(opcionarno)



RAZINA BUKE
dB(A) INT 68

M³/H INT 770

↔ 800 mm

SOFT SLIM



FUN: 330.0597.506
Crna - FENIX
Nero Ingo



(opcionarno)



NAUTILUS
TEHNOLOGIJA



RAZINA BUKE
dB(A) INT 73

M³/H INT 570

↔ 800 mm

GLAM-LIGHT



FUN: 110.0456.119 Tamno siva/
svijetlo siva
FUN: 110.0456.143 Bijela/prozirna*



RAZINA BUKE
dB(A) INT 68

M³/H INT 770

↔ 800 mm

GLAM-FIT



FUN: 330.0528.270 Crno staklo
550 mm
FUN: 330.0528.269 Crno staklo
800 mm



(opcionarno samo
za sivu napu)



NAUTILUS
TEHNOLOGIJA



RAZINA BUKE
dB(A) INT 73

M³/H INT 570

↔ 550 mm
↔ 800 mm

ZIDNE NAPE - VERTIKALNE

DAISY PLUS



FUN: 330.0612.373
Crno staklo
550 mm

FUN: 330.0612.375
Bijelo staklo
550 mm

FUN: 330.0612.374
Crno staklo
800 mm

FUN: 330.0612.371
Bijelo staklo
800 mm



(opcionarno)



INT
68



INT
770



550 mm
800 mm



STEELMAX



FUN: 330.0538.524
Crno staklo
550 mm

FUN: 330.0538.525
Bijelo staklo
550 mm

FUN: 330.0538.526
Crno staklo
800 mm

FUN: 330.0538.523
Bijelo staklo
800 mm



INT
67



INT
750



550 mm
800 mm

TWEET



FUN: 330.0529.664
Crno staklo
550 mm

FUN: 330.0529.665
Bijelo staklo
550 mm

FUN: 330.0529.666
Crno staklo
800 mm

FUN: 330.0529.667
Bijelo staklo
800 mm



INT
67



INT
710



550 mm
800 mm

VRT



FUN: 330.0567.491
Crno staklo 600 mm

FUN: 330.0567.492
Crno staklo 900 mm



MAX
67



MAX
580



600 mm
900 mm

ZIDNE NAPE - T-OBLIK

LUFT



FUN: 325.0482.910
Nehrđajući čelik
600 mm

FUN: 110.0456.293
Nehrđajući čelik
900 mm

FUN: 325.0482.952
Nehrđajući čelik
1200 mm*

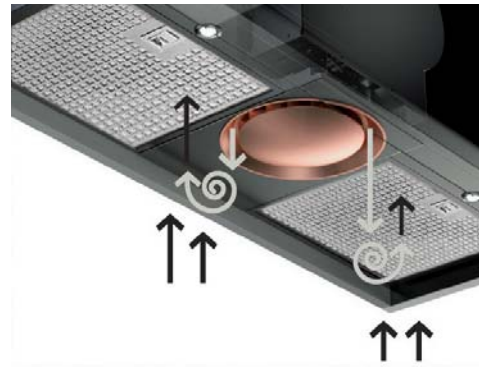
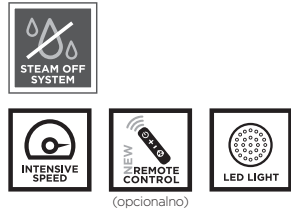

STEAM OFF
TEHNOLOGIJA

**“STEAM OFF SYSTEM” TEHNOLOGIJA
100% komfora. 0% kondenzacije.**

Faber potpuno eliminira kondenzaciju ispod i oko nape. Kontrolirani spiralni zračni mlazovi sa varijabilnom geometrijom stvaraju dva vrtloga koji kontroliraju unos dima i pare.

ECO FUNKCIJA:
promjena zraka uz
minimalnu potrošnju i
maksimalnu tišinu



A++
52 dB(A)
**PRI RADU NA
MAKSIMALNOJ
SNAZI**



ONYX-T



FUN: 325.0541.070
Nehrđajući čelik/crno staklo



T-LIGHT



FUN: 110.0456.267
Nehrđajući čelik
900 mm

FUN: 110.0456.269
Bijela mat
900 mm

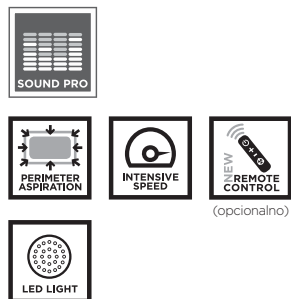

ZIDNE NAPE - T-OBLIK

T-DARK



FUN: 325.0652.937
Crni nehrđajući čelik 900 mm

- SOUND PRO
- REMOTE BLOWER (opcionálno)
- INTENSIVE SPEED
- FILTER ALARM
- NEW REMOTE CONTROL (opcionálno)
- LED LIGHT
- A++** ENERGY
- RAZINA BUKE dB(A) INT 71
- M³/H INT 780
- ↔ 900 mm



BELLA SILENCE



FUN: 325.0658.631
Nehrdajući čelik

- SOUND PRO
- REMOTE BLOWER (opcionálno)
- INTENSIVE SPEED
- NEW REMOTE CONTROL (opcionálno)
- LED LIGHT
- A+** ENERGY
- RAZINA BUKE dB(A) INT 68
- M³/H INT 750
- ↔ 900 mm

STILO GLASS SMART



FUN: 325.0617.017
Nehrdajući čelik/crno staklo 600 mm

FUN: 325.0617.016
Nehrdajući čelik/crno staklo 900 mm

- SOUND PRO
- HIGH FILTERING KIT (opcionálno)
- REMOTE BLOWER (opcionálno)
- INTENSIVE SPEED
- 30 DELAY 30
- LED LIGHT
- B**
- RAZINA BUKE dB(A) INT 69
- M³/H INT 710
- ↔ 600 mm / 900 mm

STILO COMFORT



FUN: 325.0615.637
Nehrd. čelik 600 mm

FUN: 325.0618.791
Crna mat 600 mm

FUN: 325.0615.636
Nehrd. čelik 900 mm

FUN: 325.0618.783
Crna mat 900 mm

FUN: 325.0615.638
Nehrd. čelik 1200 mm*

FUN: 325.0618.787
Crna mat 1200 mm*

- SOUND PRO
- HIGH FILTERING KIT (opcionálno)
- REMOTE BLOWER (opcionálno)
- INTENSIVE SPEED
- LED LIGHT
- B**
- RAZINA BUKE dB(A) INT 69
- M³/H INT 710
- ↔ 600 mm / 900 mm

STILO SMART



FUN: 325.0615.633
Nehrdajući čelik 600 mm

FUN: 325.0615.635
Nehrdajući čelik 900 mm

- SOUND PRO
- HIGH FILTERING KIT (opcionálno)
- REMOTE BLOWER (opcionálno)
- LED LIGHT
- C**
- RAZINA BUKE dB(A) MAX 67
- M³/H MAX 430
- ↔ 600 mm / 900 mm

*isključivo po narudžbi

**do isteka zaliha

ZIDNE NAPE - T-OBLIK

RAY



FUN: 325.0617.020
Nehrdajući čelik/ staklo 600 mm

FUN: 325.0617.051
Nehrdajući čelik/ staklo 900 mm



KIT (opcionalno)



(opcionalno)



RAZINA BUKE
dB(A) MAX
67

M³/H MAX
420

↔ 600 mm
900 mm

NICE



FUN: 325.0617.052
Nehrdajući čelik/staklo 600 mm

FUN: 325.0617.053
Nehrdajući čelik/staklo 900 mm



KIT (opcionalno)



(opcionalno)



RAZINA BUKE
dB(A) MAX
67

M³/H MAX
420

↔ 600 mm
900 mm

ZIDNE NAPE - KAMINSKE

TGL



FUN: 325.0568.803
Nehrdajući čelik/staklo 900 mm



RAZINA BUKE
dB(A) MAX
68

M³/H MAX
580

↔ 900 mm

TENDER



FUN: 110.0157.048
Nehrdajući čelik 600 mm

FUN: 110.0157.049
Nehrdajući čelik 900 mm



(opcionalno)



RAZINA BUKE
dB(A) MAX
68

M³/H MAX
400

↔ 600 mm
900 mm

STRIP SMART EV8



FUN: 320.0533.680
Nehrdajući čelik 600 mm

FUN: 320.0533.761
Nehrdajući čelik 900 mm



(opcionalno)



RAZINA BUKE
dB(A) BOOST
67

M³/H BOOST
740

↔ 600 mm
900 mm

STRIP SMART PB



FUN: 320.0685.190
Crna 600 mm

FUN: 320.0685.191
Crna 900 mm

FUN: 320.0685.189
Nehrd. čelik 900 mm



(opcionalno)



RAZINA BUKE
dB(A) MAX
63

M³/H MAX
400

↔ 600 mm
900 mm

ZIDNE NAPE - KAMINSKE

VALUE BK



FUN: 320.0557.543
Crna 600 mm

FUN: 320.0557.544
Crna 900 mm



RAZINA BUKE dB(A) MAX 67

M³/H MAX 380

↔ 600 mm
900 mm

VALUE



FUN: 320.0557.533
Nehrđajući čelik 600 mm

FUN: 320.0557.534
Nehrđajući čelik 900 mm



RAZINA BUKE dB(A) MAX 64

M³/H MAX 380

↔ 600 mm
900 mm

OTOČNE NAPE



T-SHELF*



FUN: 325.0606.131
Crna mat

FUN: 325.0617.018
Titanij mat*



RAZINA BUKE dB(A) INT 69

M³/H INT 710

↔ 1800 mm

THEA ISOLA



FUN: 321.0517.781
Bijela mat*

FUN: 112.0516.431
Kit inox okvir

FUN: 321.0517.782
Tamno siva mat

FUN: 112.0516.432
Kit drv. hrast okvir



RAZINA BUKE dB(A) INT 67

M³/H INT 740

↔ 800 mm

* Dimnjak je potreban kod ekstrakcijske izvedbe nape





CORINTHIA ISOLA



FUN: 110.0456.220
Tam. siva mat/beton

FUN: 110.0456.219
Bijela mat/
tibetansko srebrna

FUN: 110.0456.261
Nehrdajući čelik/
stari metal*



(opcionarno)



RAZINA BUKE
dB(A) INT
69

M³/H INT
700

↔ 370 mm

CYLINDRA ISOLA PLUS



FUN: 335.0572.104
Crna mat



(opcionarno)



(opcionarno)



RAZINA BUKE
dB(A) INT
69

M³/H INT
700

↔ 370 mm



CYLINDRA ISOLA GLOSS PLUS



FUN: 335.0492.563
Bijela sjajna



(opcionarno)



(opcionarno)



RAZINA BUKE
dB(A) INT
69

M³/H INT
700

↔ 370 mm

CYLINDRA ISOLA



FUN: 110.0332.308
Nehrdajući čelik



(opcionarno)



(opcionarno)



RAZINA BUKE
dB(A) INT
68

M³/H INT
660

↔ 370 mm

OTOČNE NAPE

CUBIA ISOLA GLOSS PLUS



FUN: 335.0502.100
Bijela sjajna

SOUND PRO

REMOTE BLOWER (opcionalno) PERIMETER ASPIRATION INTENSIVE SPEED

30 DELAY 30 24 HOUR 24 FILTER ALARM

REMOTE CONTROL (opcionalno) LED LIGHT

C RAZINA BUKE dB(A) INT 68

M³/H INT 680 ↔ 600 mm

T-LIGHT ISOLA



FUN: 110.0456.264
Nehrdajući čelik

FUN: 110.0456.265
Bijela mat*

SOUND PRO

PERIMETER ASPIRATION INTENSIVE SPEED NEW REMOTE CONTROL (opcionalno)

LED LIGHT

A RAZINA BUKE dB(A) INT 68

M³/H INT 700 ↔ 1000 mm

BELLA SILENCE ISOLA



FUN: 325.0658.190
Nehrdajući čelik

SOUND PRO

REMOTE BLOWER (opcionalno) INTENSIVE SPEED NEW REMOTE CONTROL (opcionalno)

LED LIGHT

A+ RAZINA BUKE dB(A) INT 68

M³/H INT 750 ↔ 900 mm

STILO GLASS SMART ISOLA



FUN: 325.0618.802
Nehrdajući čelik 900 mm

SOUND PRO

HIGH FILTERING KIT (opcionalno) REMOTE BLOWER (opcionalno) INTENSIVE SPEED

LED LIGHT

B RAZINA BUKE dB(A) INT 69

M³/H INT 710 ↔ 900 mm

STILO COMFORT ISOLA



FUN: 325.0618.738
Nehrdajući čelik 900 mm

FUN: 325.0618.792
Crna mat 900 mm

SOUND PRO

HIGH FILTERING KIT (opcionalno) REMOTE BLOWER (opcionalno) INTENSIVE SPEED

LED LIGHT

B RAZINA BUKE dB(A) INT 69

M³/H INT 710 ↔ 900 mm



*isključivo po narudžbi

**do isteka zaliha

OTOČNE NAPE

GLASSY ISOLA/SP



FUN: 325.0617.019
Nehrdajući čelik/staklo



(opcionarno)



B

RAZINA BUKE
dB(A) INT 70

M³/H INT 700

↔ 900 mm

TRATTO ISOLA/SP



FUN: 325.0628.236
Nehrdajući čelik/staklo



(opcionarno)



B

RAZINA BUKE
dB(A) INT 70

M³/H INT 700

↔ 900 mm

KUTNE NAPE



SOLARIS



FUN: 320.0538.968
Nehrdajući čelik



(opcionarno)



C

RAZINA BUKE
dB(A) MAX 63

M³/H MAX 600

↔ 1000x 1000 mm

UGRADBENE I TELESKOPSKE NAPE

ILMA TOUCH



FUN: 305.0567.012
Nehrdajući čelik
600 mm

FUN: 305.0567.013
Nehrdajući čelik
900 mm

FUN: 305.0567.014
Nehrdajući čelik
1200 mm*



A
ENERGY

RAZINA BUKE
dB(A) INT 70

M³/H INT 430

↔ 600 mm
900 mm
1200 mm

STEAM OF SYSTEM:

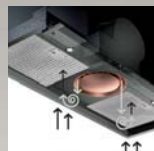

UGRADBENE I TELESKOPSKE NAPE

ILMA



FUN: 305.0482.953
Nehrdajući čelik
600 mm

FUN: 110.0456.294
Nehrdajući čelik
900 mm

FUN: 305.0482.954
Nehrdajući čelik
1200 mm*



(opcionarno)

STEAM OFF SYSTEM:

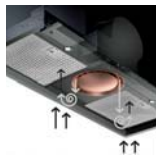

RAZINA BUKE
dB(A) INT 70

M³/H INT 430

600 mm
900 mm
1200 mm

HAVA



FUN: 325.0570.133
Nehrdajući čelik
780 mm



(opcionarno)

STEAM OFF SYSTEM:

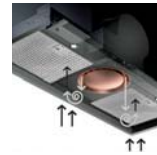

RAZINA BUKE
dB(A) INT 67

M³/H INT 710

780 mm

IN-NOVA ZERO DRIP



FUN: 305.0626.490
Nehrdajući čelik/
bijelo staklo 600 mm

FUN: 305.0626.489
Nehrdajući čelik/
bijelo staklo 900 mm

FUN: 305.0626.531
Nehrd. čelik/bijelo
staklo 1200 mm*



(opcionarno)



RAZINA BUKE
dB(A) INT 69

M³/H INT 710

600 mm
900 mm
1200 mm

IN-NOVA TOUCH



FUN: 305.0611.152
Nehrdajući čelik/crno staklo 600 mm

FUN: 305.0611.153
Nehrdajući čelik/crno staklo 900 mm

FUN: 305.0611.154
Nehrdajući čelik/crno staklo 1200 mm*



(opcionarno)



(opcionarno)



RAZINA BUKE
dB(A) INT 69

M³/H INT 670

600 mm
900 mm
1200 mm

IN-NOVA PREMIUM



FUN: 110.0439.940
Nehrdajući čelik/
staklo 600 mm

FUN: 305.0569.170
Nehrdajući čelik/
staklo 750 mm

FUN: 305.0625.239
Crna mat/staklo
600 mm

FUN: 110.0439.951
Nehrdajući čelik/
staklo 900 mm

FUN: 110.0439.952
Nehrdajući čelik/
staklo 1200 mm*

FUN: 305.0625.238
Crna mat/staklo
900 mm

FUN: 305.0625.237
Crna mat/staklo
1200 mm

FUN: 305.0621.943
Nehrdajući čelik/staklo
K-LINK 600 mm*

FUN: 305.0621.942
Nehrdajući čelik/staklo
K-LINK 900 mm*

FUN: 305.0621.941
Nehrdajući čelik/staklo
K-LINK 1200 mm*



SISTEM ZA AUTOMATSKO AKTIVIRANJE KUHINJSKE NAPE

Senzor koji omogućuje samoaktivirajuće pokretanje kuhinjske nape, samo kada je to potrebno. Tako je omogućeno optimalno iskorištenje usisa nape i olakšan rad u kuhinji.

Napomena: Ova funkcija ne radi ispravno u kombinaciji s indukcijskim pločama. Napa se može automatski pokrenuti pri temperaturi prostorije višoj od 35°C.

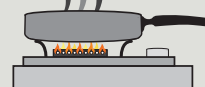
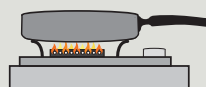

(opcionarno)



RAZINA BUKE
dB(A) INT 69

M³/H INT 670

600 mm
750 mm
900 mm
1200 mm

*K-LINK samo neki modeli

UGRADBENE I TELESKOPSKE NAPE

ULTRA SLIM



FUN: 305.0655.735
Nehrdajući čelik 600 mm

FUN: 305.0655.737
Nehrdajući čelik 900 mm

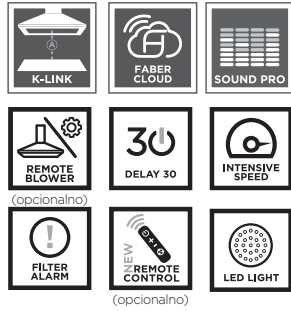

B RAZINA BUKE dB(A) INT 67
M³/H INT 750 ↔ 600 mm 900 mm

IN-NOVA COMFORT



FUN: 110.0439.937
Nehrdajući čelik 600 mm

FUN: 110.0439.938
Nehrdajući čelik 900 mm

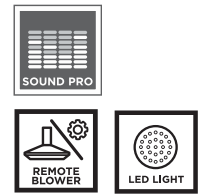

C RAZINA BUKE dB(A) MAX 65
M³/H MAX 570 ↔ 600 mm 900 mm

IN-NOVA SMART



FUN: 305.0557.680
Nehrdajući čelik 600 mm

FUN: 305.0557.691
Nehrdajući čelik 900 mm



D RAZINA BUKE dB(A) MAX 68
M³/H MAX 360 ↔ 600 mm 900 mm



IN-LIGHT



FUN: 110.0456.213
Nehrdajući čelik 520 mm

FUN: 110.0456.215
Nehrdajući čelik 700 mm

FUN: 110.0456.216
Bijela mat 520 mm

FUN: 110.0456.218
Bijela mat 700 mm

FUN: 305.0628.270
Crna mat 520 mm

FUN: 305.0628.321
Crna mat 700 mm

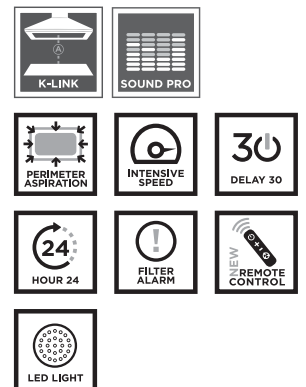

A RAZINA BUKE dB(A) INT 69
M³/H INT 710 ↔ 520 mm 700 mm

UGRADBENE I TELESKOPSKE NAPE

INKA LUX 3.0 PREMIUM



FUN: 305.0658.601 Nehrđajuci čelik K-LINK 520 mm
FUN: 305.0658.602 Nehrđajuci čelik K-LINK 700 mm
FUN: 305.0658.608 Nehr. čelik/ crna mat K-LINK 520 mm
FUN: 305.0658.609 Nehr. čelik/ crna mat K-LINK 700 mm

| | | | |
|------------------------|----------------------------------|--------------------------|------------------|
| A | 700 mm | RAZINA BUKE dB(A) | INT 68 (700 mm) |
| B | 520 mm | RAZINA BUKE dB(A) | INT 69 (520 mm) |
| M³/H | INT 670 (520 mm) 720 (700 mm) | ↔ | 520 mm 700 mm |



INKA LUX 3.0 EVO

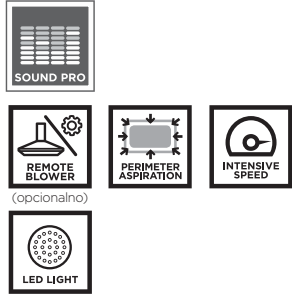

FUN: 305.0665.353 Nehrđajuci čelik 520 mm
FUN: 305.0665.354 Nehrđajuci čelik 700 mm
FUN: 305.0665.357 Nehr. čelik/ bijela mat 520 mm
FUN: 305.0665.358 Nehr. čelik/ bijela mat 700 mm
FUN: 305.0665.355 Nehr. čelik/ crna mat 520 mm
FUN: 305.0665.356 Nehr. čelik/ crna mat 700 mm

| | | | |
|------------------------|----------------------------------|--------------------------|------------------|
| B | | RAZINA BUKE dB(A) | INT 66 (700 mm) |
| M³/H | INT 620 (520 mm) 670 (700 mm) | ↔ | 520 mm 700 mm |

INKA LUX SMART



FUN: 305.0604.603 Nehrđajuci čelik 520 mm
FUN: 305.0604.604 Nehrđajuci čelik 700 mm

| | | | |
|------------------------|-----------|--------------------------|------------------|
| B | | RAZINA BUKE dB(A) | BOOST 68 |
| M³/H | BOOST 690 | ↔ | 520 mm 700 mm |

INKA PLUS HCS



FUN: 305.0602.049 Nehrđajuci čelik 520 mm
FUN: 305.0602.050 Nehrđajuci čelik 700 mm
FUN: 305.0628.322 Crna 520 mm
FUN: 305.0628.323 Crna 700 mm

| | | | |
|------------------------|---------|--------------------------|------------------|
| B | | RAZINA BUKE dB(A) | MAX 63 |
| M³/H | MAX 590 | ↔ | 520 mm 700 mm |

INKA PLUS HC



FUN: 305.0602.047 Nehrđajuci čelik 520 mm
FUN: 305.0602.048 Nehrđajuci čelik 700 mm

| | | | |
|------------------------|---------|--------------------------|------------------|
| B | | RAZINA BUKE dB(A) | MAX 63 |
| M³/H | MAX 590 | ↔ | 520 mm 700 mm |

UGRADBENE I TELESKOPSKE NAPE

INKA SMART HCS



FUN: 305.0599.323
Nehrđajući čelik 520 mm

FUN: 305.0599.321
Nehrđajući čelik 700 mm



RAZINA BUKE dB(A) MAX 70

M³/H MAX 390

↔ 520 mm / 700 mm

INKA SMART HC



FUN: 305.0599.307
Nehrđajući čelik 520 mm

FUN: 3305.0599.308
Nehrđajući čelik 700 mm



RAZINA BUKE dB(A) MAX 70

M³/H MAX 390

↔ 520 mm / 700 mm

INKA SMART C



FUN: 305.0599.305
Svijetlo siva 520 mm

FUN: 305.0599.306
Svijetlo siva 700 mm



RAZINA BUKE dB(A) MAX 66

M³/H MAX 335

↔ 520 mm / 700 mm

MAXIMA TOUCH



(opcionally)



FUN: 315.0635.146
Aluminij/ maska od nehrđajućeg čelika 600 mm

FUN: 315.0635.147
Aluminij/ maska od nehrđajućeg čelika 900 mm



RAZINA BUKE dB(A) INT 66

M³/H INT 740

↔ 600 mm / 900 mm

MAXIMA ECO



(opcionally)



FUN: 315.0635.140
Aluminij/ maska od nehrđajućeg čelika 600 mm

FUN: 315.0635.143
Aluminij/ maska od nehrđajućeg čelika 900 mm



RAZINA BUKE dB(A) MAX 63

M³/H MAX 620

↔ 600 mm / 900 mm

FLEXA GLASS LUX



FUN: 315.0635.138
Bijela / staklena maska

FUN: 315.0635.137
Crna / staklena maska



RAZINA BUKE dB(A) MAX 69

M³/H MAX 420

↔ 600 mm

UGRADBENE I TELESKOPSKE NAPE

FLEXA GLASS



FUN: 315.0635.107
Bijela / staklena maska

FUN: 315.0635.106
Crna / staklena maska



RAZINA BUKE
dB(A) MAX
67

M³/H MAX
310

↔ 600 mm

FLEXA HIP



FUN: 315.0635.133
Aluminij/ maska od
nehrđajućeg čelika



RAZINA BUKE
dB(A) MAX
69

M³/H MAX
420

↔ 600 mm

FLEXA



FUN: 315.0635.102
Bijela / maska od
nehrđajućeg čelika



RAZINA BUKE
dB(A) MAX
69

M³/H MAX
350

↔ 600 mm

152



FUN: 315.0547.802
Svijetlo siva 600 mm

FUN: 315.0547.803
Svijetlo siva 900 mm



RAZINA BUKE
dB(A) MAX
68

M³/H MAX
225

↔ 600 mm
↔ 900 mm

KLASIČNE NAPE

2740 PB



FUN: 300.0557.570
Bijela

FUN: 300.0557.569
Nehrđajući čelik



RAZINA BUKE
dB(A) MAX
70

M³/H MAX
380

↔ 600 mm

741 BASE



FUN: 300.0557.479
Nehrđajući čelik

FUN: 300.0557.477
Bijela

FUN: 300.0557.508
Smeđa/
nehrđajući čelik

FUN: 300.0557.499
Smeđa



RAZINA BUKE
dB(A) MAX
72

M³/H MAX
305

↔ 600 mm

PRIBOR

GALILEO

SETOVI ZA UGRADNJU ZA MODELE:

Galileo NG, Galileo Smart i Galileo 60



Video s uputama

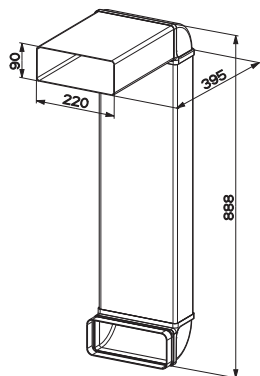

ODVODNI SET PRIKLADAN ZA SVE GALILEO NAPE*

Odvodni set
FUN 112.0540.782

- 1 x pravokutna cijev, 200 x 90 x 300 mm
- 2 x koljeno 90°, 220 x 90 mm
- 1 x pravokutna cijev, 200 x 90 x 700 mm
- 1 x adapter za cijev

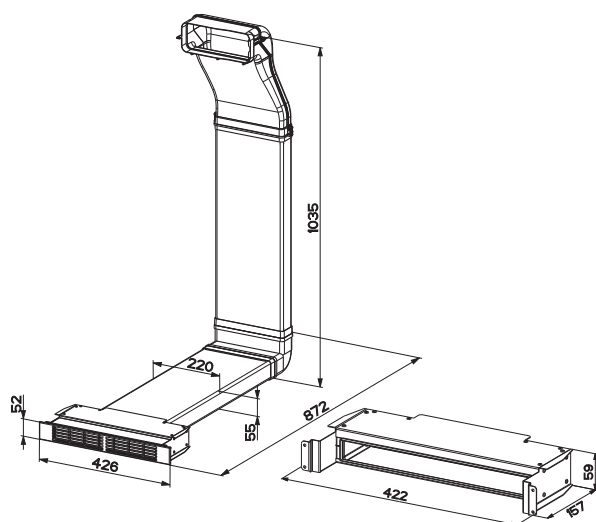

ODVODNI SET GALILEO 60*

Odvodni set za filtracijski mod H60
FUN 112.0626.656

- 2 x okomite spojnice (stražnja i prednja) za spajanje na motor
- 1 x spojnica s brtvom, 220 x 55 mm
- 2 x pravokutna cijev, 220 x 55 x 600 mm
- 1 x koljeno 90°, 220 x 55 mm
- Set za filtracijski mod H60

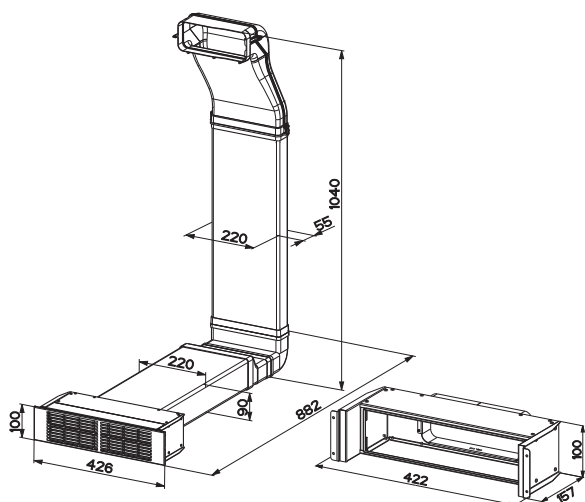

ODVODNI SET GALILEO 60*

Odvodni set za filtracijski mod H100
FUN 112.0626.657

- 2 x okomite spojnice (stražnja i prednja) za spajanje na motor
- 1 x spojnica s brtvom, 220 x 55 mm
- 1 x pravokutna cijev, 220 x 55 x 600 mm
- 1 x koljeno 90°, 220 x 55 mm
- 1 x pravokutna redukcija, 90-55 mm
- 1 x pravokutna spojnica, 200 x 90 mm
- 1 x pravokutna cijev, 220 x 90 x 500 mm
- Set za filtracijski mod H100

PLOČE S INTEGRIRANOM NAPOM.

Za ugradnju Galileo ploča za kuhanje s integriranom napom morat ćete kupiti odgovarajući komplet za ugradnju. Dostupni su različiti kompleti, ovisno o željenom modelu i konfiguraciji, usisnoj ili filtarskoj. Pojediniosti o svakom pojedinačnom kompletu, s komponentama uključenim u pakiranje, navedene su u nastavku.

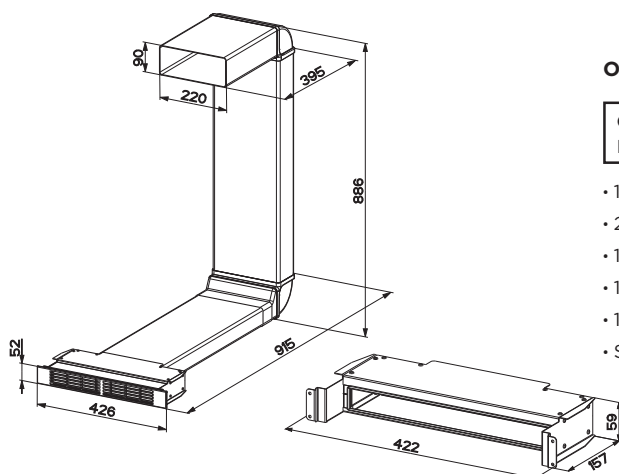
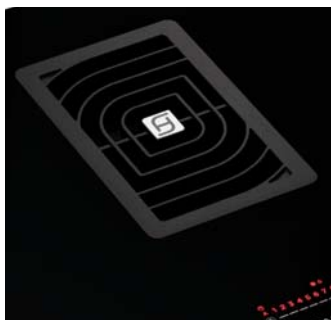

ODVODNI SET GALILEO 80*

Odvodni set za filtracijski mod H60
FUN 112.0540.730

- 1 x pravokutna cijev, 200 x 90 x 300 mm
- 2 x koljeno 90°, 220 x 90 mm
- 1 x pravokutna cijev, 200 x 90 x 700 mm
- 1 x pravokutna redukcija, 90-55 mm
- 1 pravokutna cijev, 220 x 55 x 600 mm
- Set za filtracijski mod H60

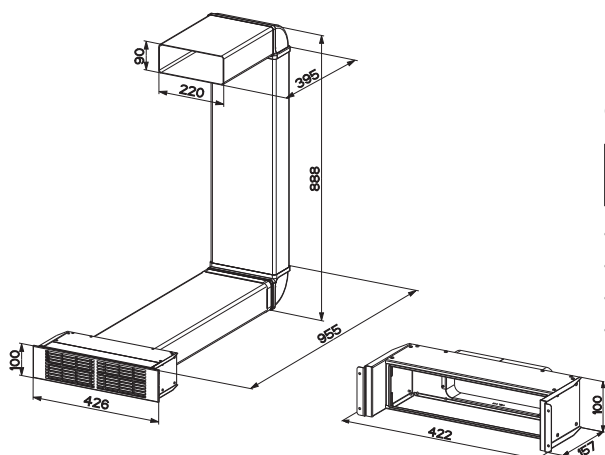

ODVODNI SET GALILEO 80*

Odvodni set za filtracijski mod H100
FUN 112.0540.781

- 1 x pravokutna cijev, 200 x 90 x 300 mm
- 2 x koljeno 90°, 220 x 90 mm
- 2 x pravokutna cijev, 200 x 90 x 700 mm
- Set za filtracijski mod H100

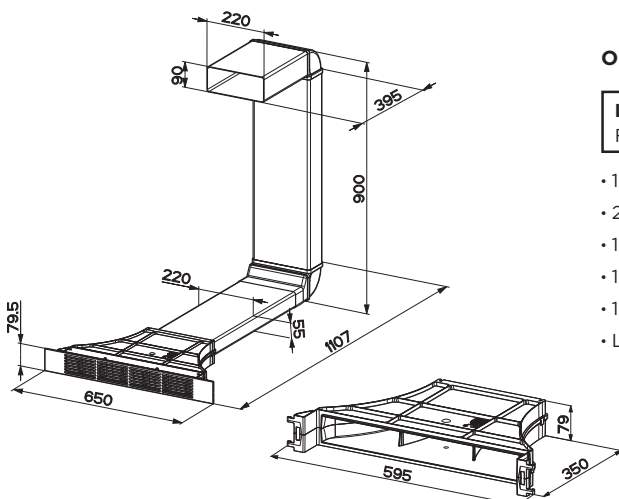

ODVODNI SET GALILEO 80*

Long lasting H80 odvodni set za filtracijski mod
FUN 112.0605.735

- 1 x pravokutna cijev, 200 x 90 x 300 mm
- 2 x koljeno 90°, 220 x 90 mm
- 1 x pravokutna cijev, 200 x 90 x 700 mm
- 1 x pravokutna redukcija, 90-55 mm
- 1 pravokutna cijev, 220 x 55 x 600 mm
- LL H80 kit

GALILEO

SETOVI ZA UGRADNJU ZA MODELE:



Video s uputama,
ekstrakcijski mod



Video s uputama,
filtracijski mod

Galileo Stripes, Galileo Bold, Galileo Linear i Galileo Slim

Za ugradnju novih Galileo indukcijskih ploča s integriranom napom u ekstrakcijskom načinu rada potrebno je kupiti odgovarajući komplet za ugradnju.

Za filtracijski način rada, komplet sa stražnjim izlazom se standardno isporučuje sa uređajem, ali također je moguće odvod zraka postaviti u dno kuhinjskog elementa kupnjom odgovarajućeg seta za ugradnju.

Ispod su pojedini seti o svakom pojedinačnom setu s popisom komponenti od kojih se sastoji.

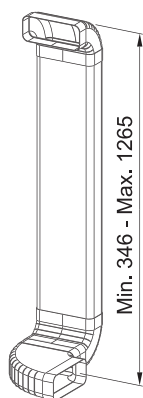

ODVODNI SET

Odvodni set za ekstrakcijski mod
FUN 112.0711.356

- 1 x 90° horizontalno koljeno
- 2 x 90° koljeno
- 1 x pravokutna cijev 220x90x1000
- 1 x ljepljiva traka

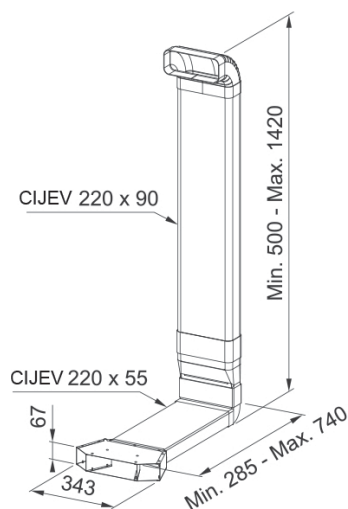

ODVODNI SET

Odvodni set za filtracijski mod/ visina cokla 70 mm
FUN 112.0711.987

- 1 x 90° koljeno 220x90
- 1 x spojnica difuzora zraka 220x55
- 1 x 90° koljeno 220x90
- 1 x pravokutna cijev 220x90x1000
- 1 x pravokutna spojnica 220x90
- 1 x ljepljiva traka
- 1 x pravokutna cijev 220x55x1000
- 1 x 90° koljeno 220x55
- 1 x pravokutna spojnica 220x55
- 1 x pravokutna spojnica 90-55
- 1 x difuzor zraka

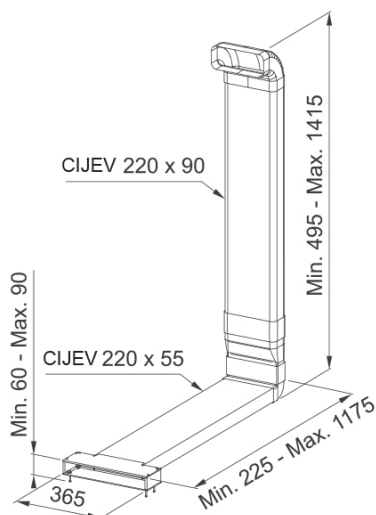

ODVODNI SET

Odvodni set za filtracijski mod/ visina cokla 60 mm
FUN 112.0711.988

- 1 x 90° koljeno 220x90
- 1 x 90° koljeno 220x90
- 1 x pravokutna cijev 220x90x1000
- 1 x pravokutna spojnica 220x90
- 1 x pravokutna spojnica 90-55
- 1 x pravokutna spojnica 220x55
- 1 x koljeno 220x55
- 1 x pravokutna cijev 220x55x1000
- 1 x difuzor zraka
- 1 x ljepljiva traka

GALILEO

SET ZA FILTRACIJSKU VERZIJU I FILTERI ZA MODELE:



Video s uputama

Galileo NG, Galileo Smart i Galileo 60



SET STRAŽNJEG FILTERA

Set stražnjeg filtera
FUN 112.0685.046

- Galileo NG
- Galileo
- Galileo Smart
- Galileo 60



KERAMIČKI FILTER

Keramički filter H100
FUN 112.0548.448

- Galileo NG
- Galileo
- Galileo Smart
- Galileo 60



KERAMIČKI FILTER

Keramički filter H60
FUN 112.0548.447

- Galileo NG
- Galileo
- Galileo Smart
- Galileo 60



LONG LASTING FILTER

Long lasting filter H80
FUN 112.0605.736

- Galileo
- Galileo Smart



LONG LASTING FILTER

Long lasting filter HE 60cm H80
FUN 112.0679.153

- Galileo 60

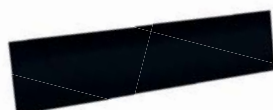

LONG LASTING FILTER

Long lasting stražnji filter HE
FUN 112.0684.122

- Galileo NG
- Galileo
- Galileo Smart
- Galileo 60



FILTER ZA MODELE:

Galileo Stripes, Galileo Bold, Galileo Linear i Galileo Slim



Video s uputama,
ekstrakcijski mod



Video s uputama,
filtracijski mod



LONG LASTING FILTER

Long lasting filter HE
FUN 112.0716.092

- Galileo Stripes
- Galileo Bold
- Galileo Linear
- Galileo Slim

GALILEO

ODVODNI ELEMENTI ZA MODELE:

Galileo NG, Galileo Smart i Galileo 60



Video s uputama

PRAVOKUTNA CIJEV TR 1500 220X55X1500 MM FUN 112.0157.294

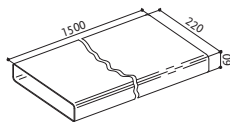

SPOJNICA RRC FUN 112.0157.296

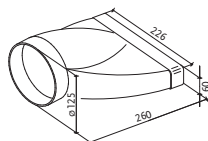

KOLJENO CRCV 90 REVERZIBILNO FUN 112.0157.298

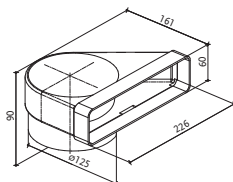

KOLJENO CRO 90 FUN 112.0157.300

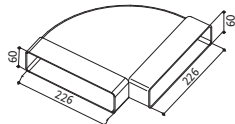

ROZETA GRE FUN 112.0157.304

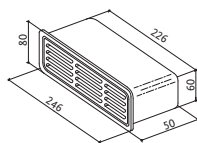

KOLJENO CRCO 90 REVERZIBILNO FUN 112.0157.306

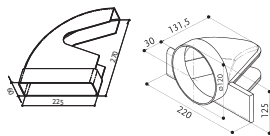

CIJEV TC 1000 FUN 112.0157.308

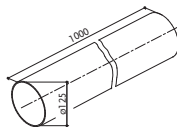

PRAVOKUTNA SPOJNICA FUN 112.0157.295

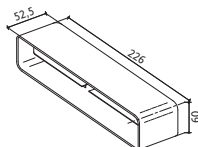

SPOJNICA RPR FUN 112.0157.297

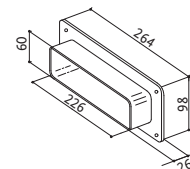

KOLJENO CRV 90 FUN 112.0157.299

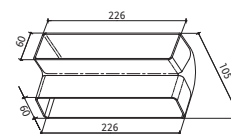

PRAVOKUTNA REDUKCIJA 60H FUN 112.0557.017

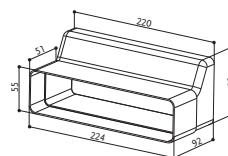

ROZETA GDC 125 FUN 112.0157.303

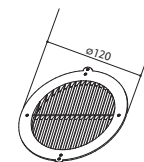

NOSAČ FRF FUN 112.0157.305

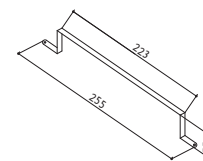

KOLJENO CC 90 FUN 112.0157.307

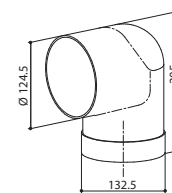

SPOJNICA 2 FR FUN 112.0157.309

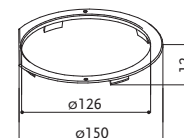

PRAVOKUTNA CIJEV TR 1200 220X90 MM FUN 112.0459.427

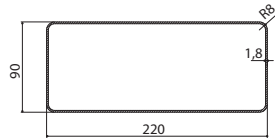

PRAVOKUTNA SPOJNICA 220X90 MM FUN 112.0459.428

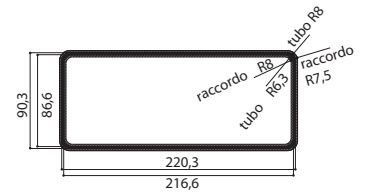

SPOJNICA RRC 220X90 MM FUN 112.0459.429

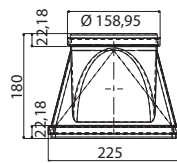

KOLJENO CRC 90 220X90 MM FUN 112.0459.451

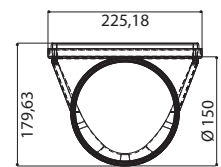

KOLJENO CRV 90 220X90 MM FUN 112.0459.453

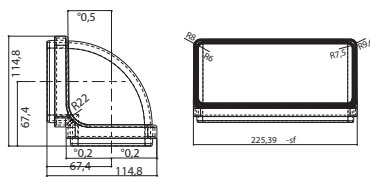

KOLJENO CRO 90 220X90 MM FUN 112.0459.455

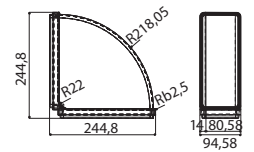

NOSAČ FRF 220X90 MM FUN 112.0459.456

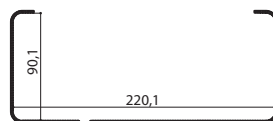

CIJEV TC 1000 Ø 150 MM FUN 112.0253.681

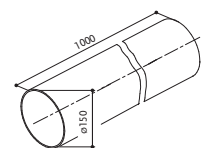

FLEKSIBILNA SPOJNICA RF 600 FUN 112.0280.685

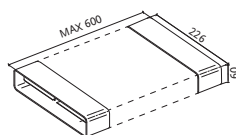

OKRUGLA SPOJNICA D150 FUN 112.0253.690

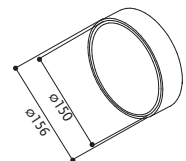

KOLJENO TONDA 90° D150 FUN 112.0253.688

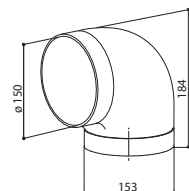

REŠETKA 220X90 FUN 112.0605.516

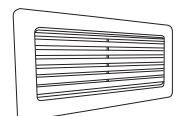

GALILEO

ODVODNI ELEMENTI ZA MODELE:



Video s uputama,
ekstrakcijski mod



Video s uputama,
filtracijski mod

Galileo Stripes, Galileo Bold, Galileo Linear i Galileo Slim

FUN 112.0711.855

Spojnicica 90°, okruglo / pravkutno

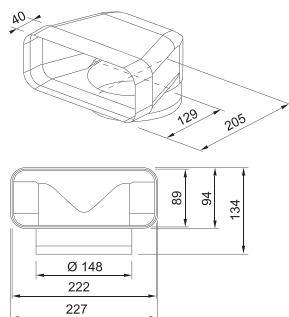

FUN 112.0711.860

Spojnicica za okruglu cijev

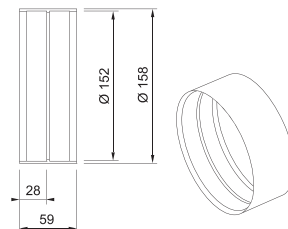

FUN 112.0711.856

Okrugla cijev Ø150 L=500 mm

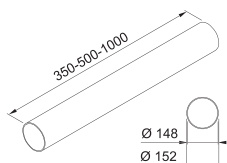

FUN 112.0711.852

Vertikalno koljeno 90° za pravokutnu cijev

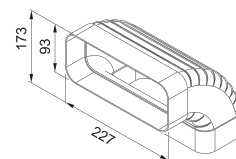

FUN 112.0711.858

Okrugla cijev Ø150 L=1000 mm



FUN 112.0711.904

Spojnicica

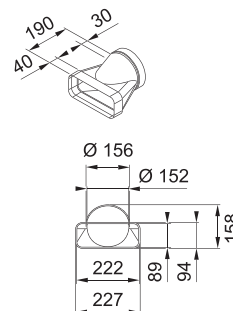

FUN 112.0711.853

Horizontalna spojnicica 90°

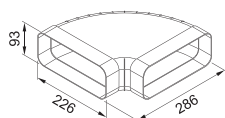

FUN 112.0711.854

Deflektor 90°

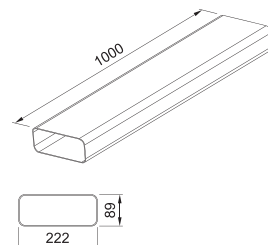

FUN 112.0711.901

Spojnicica 90° za okruglu cijev 150

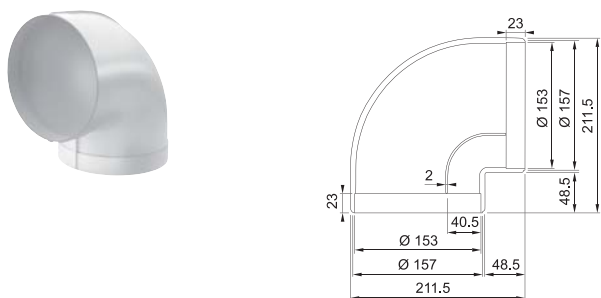

FUN 112.0711.908

Horizontalna spojnicica 15°

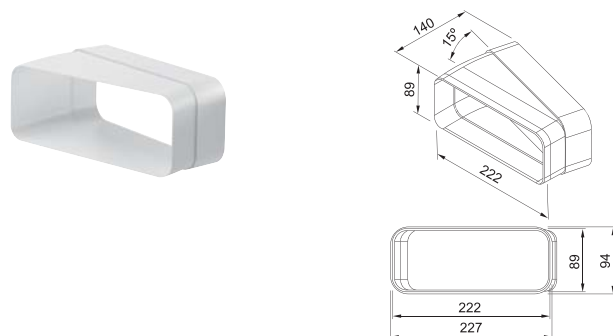

FUN 112.0711.902

Fleksibilna spojnicica 150

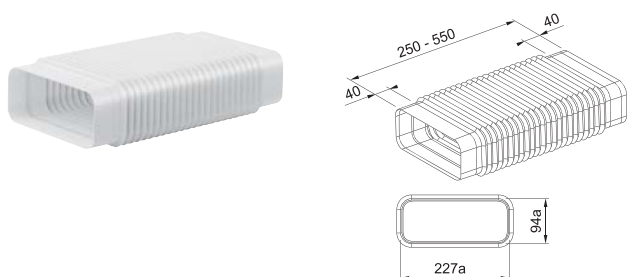

FUN 112.0711.905

Set za vanjski odvod za okruglu cijev

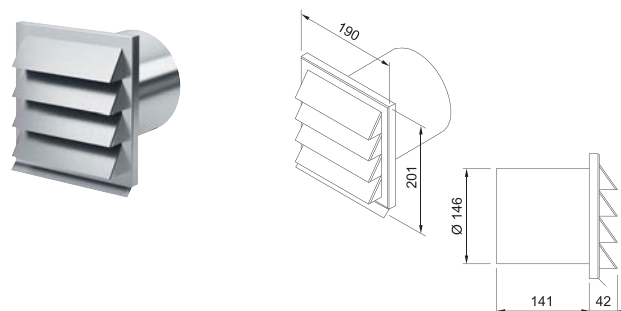

FUN 112.0711.903

Spojnicica za pravokutnu cijev

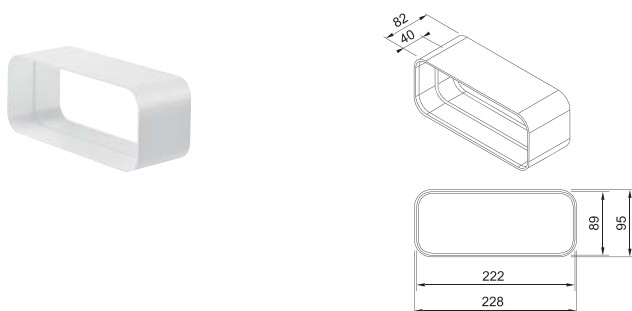

FUN 112.0711.906

Set za vanjski odvod za pravokutnu cijev

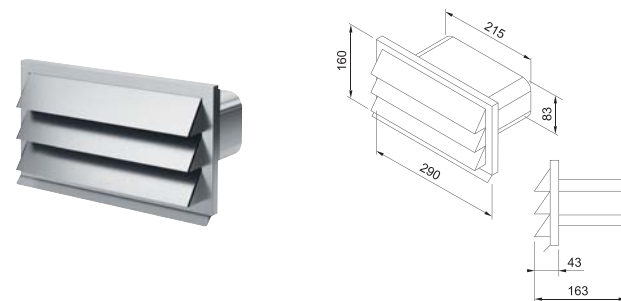

DISLOCIRANI MOTOR

RADOST ŽIVOTA U TIŠINI PLUS MOGUĆNOST FLEKSIBILNIJEG DIZAJNA KUHINJE

Sa FABER napom, buka se eliminira dislociranjem izvora buke - motora i ventilatora. Dislocirani motor tvrtke FABER dopušta uklanjanje motora iz nape i instalaciju u drugu prostoriju, ostavljajući vašu kuhinju nevjerojatno tihom. I ne postoji rizik uznemiravanja susjeda! Samo Faber Vam nudi slobodu opremanja Vaše kuhinje kako želite, bez ikakvih zapreka, i uživanje u krajnjoj udobnosti, u skladu s najnovijim trendovima.

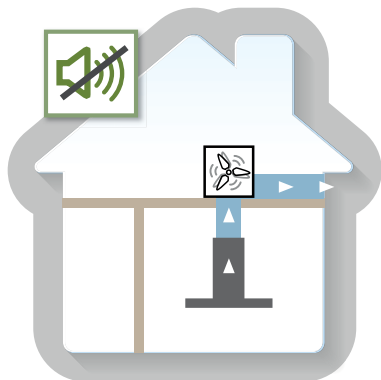
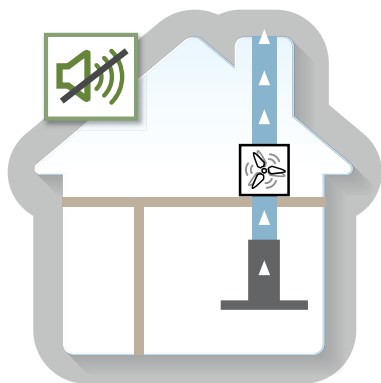
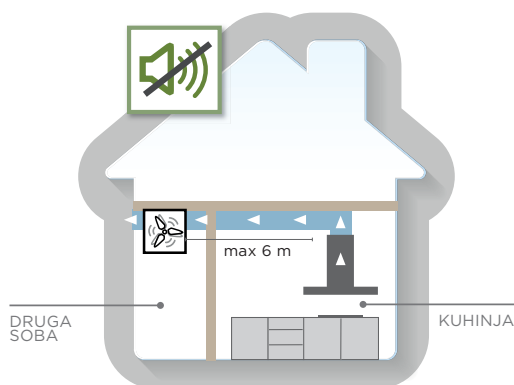

NAĐITE POZICIJU KOJA VAM ODGOVARA.

Zahvaljujući svestranom dizajnu, dislocirani motor može se postaviti ili premjestiti na bilo koji od ovdje prikazanih mjesta, tako da uvijek možete pronaći najbolji mogući položaj za smanjenje buke.

KIT DISLOCIRANI MOTOR

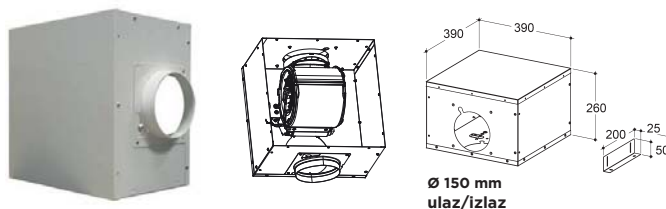

SET ZA UGRADNJU UDALJENOG MOTORA FUN 112.0327.007

- Bella Silence
- Bella Silence Isola
- Bi-Air
- Chloè
- Chloè Isola
- Chloè XL
- Cylindra
- Cylindra Plus
- Cylindra Gloss Plus
- Cylindra Isola
- Cylindra Isola Gloss Plus
- Daisy Plus
- Eclipse
- Glassy Isola/SP
- Heaven 2.0
- Heaven Glass 2.0
- Inka Lux 3.0 Premium
- Inka Lux 3.0 Evo
- In-Nova Comfort
- In-Nova Premium
- In-Nova Touch
- Maxima Touch
- Maxima Eco
- Nice
- Ray
- Solaris
- Stilo Comfort
- Stilo Comfort Isola
- Stilo Glass Smart
- Stilo Glass Smart Isola
- Stilo Smart
- Strip Smart EV8
- Strip Smart PB
- T-Dark
- Tender
- Tea
- Tratto Isola/SP
- Veil

Kit dislocirani motor je moguće ugraditi uz većinu Faber napa.

SET ZA UGRADNJU UDALJENOG MOTORA FABULA FUN 112.0327.008

- Fabula Plus

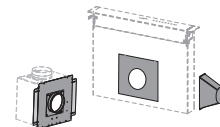

CLIN&CLIN



VLAŽNE MARAMICE (5 KOMADA) FUN 112.0157.293

*NAPOMENA
Minimalna narudžba 30 komada ili količina djeljiva sa 30

REGENERACIJSKA PASTA 55 ml FUN 112.0157.501

*NAPOMENA
Minimalna narudžba 10 komada ili količina djeljiva sa 10 (55 ml)

REGENERACIJSKA PASTA 200 ml FUN 112.0157.502

*NAPOMENA
Minimalna narudžba 6 komada ili količina djeljiva sa 6 (200 ml).

DIMNJACI

GORNJI DIMNJAK - NASTAVAK KIT ALTO H990 X FUN 112.0157.252

- Bella Silence
- Nice
- Ray

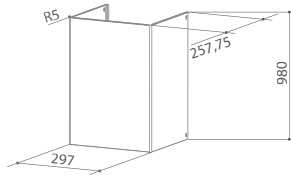

GORNJI DIMNJAK - NASTAVAK KIT ALTO BK MATT H990 FUN 112.0621.232

- Stilo Comfort BK
- T-Air

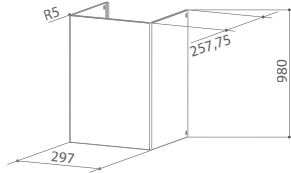

GORNJI DIMNJAK - NASTAVAK KIT H990 X FUN 112.0157.257

- Synthesis Hip

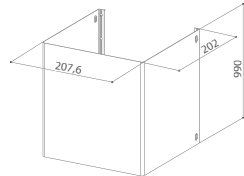

GORNJI DIMNJAK - NASTAVAK KIT SOLARIS H990 X FUN 112.0157.261

- Solaris

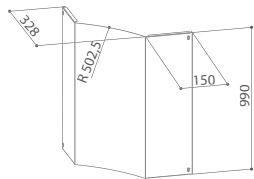

GORNJI DIMNJAK - NASTAVAK KIT TENDER H990 X FUN 112.0157.262

- Tender

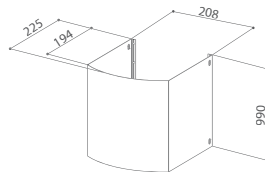

GORNJI DIMNJAK - NASTAVAK KIT PREMIO ANGOLO H990 X FUN 112.0157.263

- Stilo Angolo/SP

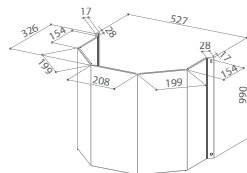

GORNJI DIMNJAK - NASTAVAK KIT ISOLA H990 D370 X FUN 112.0157.267

- Cylindra Isola

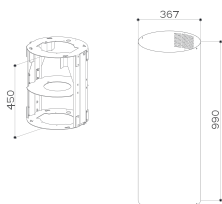

GORNJI DIMNJAK - NASTAVAK KIT ISOLA H700 X FUN 112.0157.268

- Tratto Isola/SP

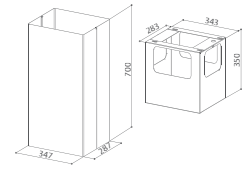

KIT A500+A500 X FUN 112.0250.289

- Cocktail X

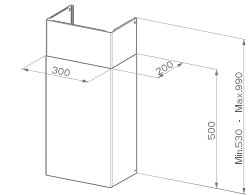

KIT A500+A500 BK FUN 112.0250.290

- Cocktail BK

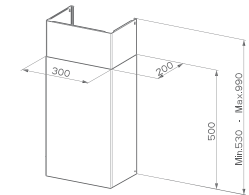

GORNJI DIMNJAK KIT ISOLA H990 D370 BIJELA FUN 112.0286.014

- Cylindra Isola

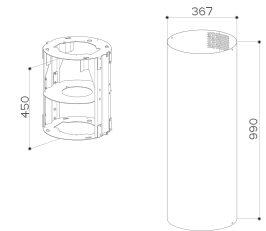

DIMNJAK ISOLA H450-590 BIJELA MAT FUN 112.0516.428

- Thea Isola

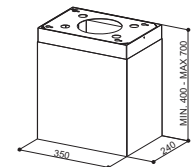

DIMNJAK ISOLA H450-590 TAMNO SIVA MAT FUN 112.0516.430

- Thea Isola

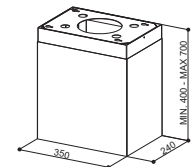

KIT DIMNJAK 300X160 H990 BK FUN 112.0569.164

- Glam Fit
- Soft Slim

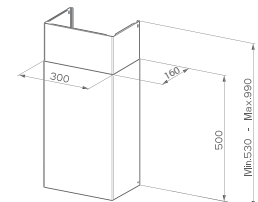

KIT DIMNJAK 300X160 H990 WH FUN 112.0569.163

- Glam Fit
- Soft Slim

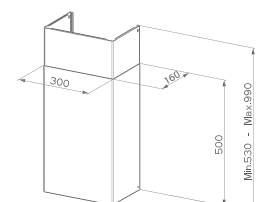

*isključivo po narudžbi

KIT ZA FILTRACIJSKU IZVEDBU NAPE

KIT POKLOPAC ODVODA WH FUN 112.0252.439

- Daisy Plus WH
- Soft Edge
- Tweet WH

KIT POKLOPAC ODVODA BK FUN 112.0252.442

- Glam-Light DG/LG
- Soft Edge
- Tweet BK

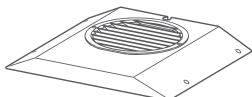

PRAVOKUTNI KIT ZA FILTRACIJSKU IZVEDBU NAPE FUN 112.0470.541

- Fabula*

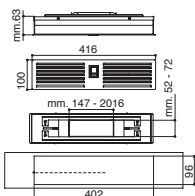

*NAPOMENA: Koristi se kao dodatak ili alternativa ugljenom filteru

KIT ZA FILTRIRANJE ZA ZIDNE NAPE T-OBLIKA FUN 112.0626.902

- Nice
- Ray
- T-Air
- T-Dark
- T-Light
- Stilo Comfort

KIT ZA FILTRIRANJE ZA OTOČNE NAPE T-OBLIKA FUN 112.0626.903

- T-Shelf
- Stilo Glass Smart Isola
- Stilo Comfort Isola
- Glassy Isola/SP
- Tratto Isola

KIT POKLOPAC ODVODA VRT, TSPG, TGL, TSP FUN 112.0571.150

- VRT
- TGL

SET ZA STRAŽNJI ODVOD ZRAKA

UKRASNI DIMNJAK ZA STRAŽNJI ODVOD ZRAKA CHLOÉ STARI METAL FUN 112.0490.249

UKRASNI DIMNJAK ZA STRAŽNJI ODVOD ZRAKA CHLOÉ STARI BAKAR FUN 112.0490.250

UKRASNI DIMNJAK ZA STRAŽNJI ODVOD ZRAKA CHLOÉ LJEVANO ŽELJEZO FUN 112.0490.261

UKRASNI DIMNJAK ZA STRAŽNJI ODVOD ZRAKA CHLOÉ STARI MESING FUN 112.0490.262

UKRASNI DIMNJAK ZA STRAŽNJI ODVOD ZRAKA CHLOÉ TAMNO SIVA MAT FUN 112.0490.263

UKRASNI DIMNJAK ZA STRAŽNJI ODVOD ZRAKA CHLOÉ COUNTRY SIVA MAT FUN 112.0490.264

- Chloé

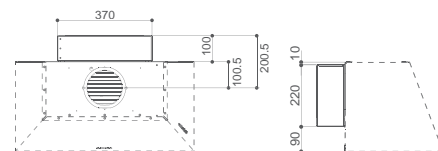

Ukrasni dimnjak je u boji nape.

DALJINSKI UPRAVLJAČ

DALJINSKI UPRAVLJAČ 7T PREMIUM FUN 112.0615.733

- | | |
|-----------------------------|------------------------|
| - Bi-Air | - Ilma |
| - Bella Silence | - In-Light |
| - Bella Silence Isola | - In-Nova Premium |
| - Belle Plus | - In-Nova Touch |
| - Celine Plus | - In-Nova Zero Drip |
| - Chloé | - Inka Lux 3.0 Premium |
| - Chloé Isola | - Inka Lux 3.0 Evo |
| - Corinthia Isola | - Onyx-T |
| - Cubia Isola Gloss Plus | - Pareo Plus |
| - Cylindra | - Soft Cube |
| - Cylindra Gloss Plus | - Soft Edge |
| - Cylindra Isola | - Soft Slim |
| - Cylindra Isola Gloss Plus | - T-Air |
| - Fabula Plus | - T-Dark |
| - Glam Fit (Grey) | - T-Light |
| - Hava | - T-Light Isola |
| - Heaven 2.0 | - V-Air |
| - High Light | |



KUTNI ADAPTER

KUTNI ADAPTER X FUN 112.0157.284

- Stilo Angolo/SP

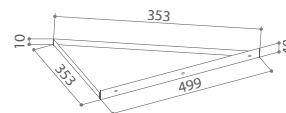

SINTETIČKI FILTER

SINTETIČKI FILTER - ROLA FUN 112.0157.289

- Inka Smart
- 152 LG
- 741 Base
- 2740 Base

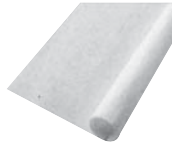

METALNI MODULARNI FILTERI

METALNI FILTER 60 FUN 112.0157.248

- 1 MOTOR
- 152 LG

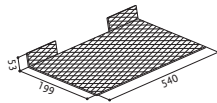

METALNI FILTER 90 FUN 112.0157.249

- 1 MOTOR
- 152 LG

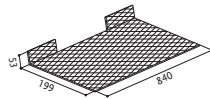

KIT FILTERA HFH GEMMA, BELLA, NICE, RAY FUN 112.0327.631

KIT FILTERA INOX IN-NOVA 60 FUN 112.0624.485

KIT FILTERA INOX IN-NOVA 90 FUN 112.0624.486

KIT FILTERA INOX IN-NOVA 120 FUN 112.0624.487

F-LIGHT ODVODNI KIT

F-LIGHT ODVODNI KIT FUN 112.0169.216

- Lybra Plus
- Zoom Plus



promjer 150 mm - dužina 1 m

AIRLANE ODVODNI KIT FUN 112.0542.875

- Belle
- Belle Plus
- Celine
- Celine Plus
- Glow
- Glow Plus
- Odette
- Odette Plus



UGLJENI FILTERI

PRAVOKUTNI UGLJENI FILTER FUN 112.0472.396

- Fabula Plus
- Hoo-B
- Hoo-B Glass



*NAPOMENA

Kombinirati s pravokutnim kitom za filtracijsku izvedbu nape FUN 112.0470.541

KIT FILTERA HAVA FUN 112.0576.982

- Hava



*NAPOMENA

Ugljeni filter sa nosačem (kit) kupuje se samo kod prve narudžbe. Nakon što se istroši, potrebno je kupiti samo ugljeni filter (refill kita filtera Hava, FUN 112.0576.981)

REFILL KITA FILTERA HAVA FUN 112.0576.981

- Hava



UGLJENI FILTERI HIGH PERFORMANCE

FHP8 HIGH PERFORMANCE (PAR) FUN 112.0158.127

- | | | | |
|------------------|--------------------|------------------|---------------|
| - Agorà | - Grèxia | - Pareo | - Trendy |
| - Bi-Air | - Heaven 2.0 | - Ranch | - Tweet |
| - Beat XL | - Heaven Air | - Soft Cube | - V-Air |
| - Beat | - Heaven Glass 2.0 | - Soft Edge | - West |
| - Belle | - In-Light | - Solaris | - Veil |
| - Belle Plus | - Inka Lux 3.0 | - Steelmax | - Zoom Plus |
| - C-Air | Premium | - Strip Smart | - 106/35 Plus |
| - Celine | - Inka Lux 3.0 Evo | - Strip Smart PB | |
| - Celine Plus | - Inka Lux Smart | - Tender | |
| - Chloé Isola | - Inka Plus HC | - Thea | |
| - Chloé XL | - Inka Plus HCS | - Thea Isola | |
| - Cocktail | - K-Air | | |
| - Cubia Plus | - Lithos | | |
| - Daisy Plus | - Maxima Eco | | |
| - Glam-Light | - Maxima Touch | | |
| - Glam Light | - Odette | | |
| - Zero Drip Plus | - Odette Plus | | |
| - Glow | - Onyx-C | | |
| - Glow Plus | - Onyx-V | | |



UGLJENI FILTERI LONG LASTING

FLL3 UGLJENI FILTER LONG LASTING (PAR) FUN 112.0544.470

- Flexa Glass Lux
- Flexa Hip
- Value



F18-90 UGLJENI FILTER 90 CM (PAR) FUN 112.0471.608

- Heaven 2.0 Flat
- Heaven Glass 2.0 Flat
- High-Light
- Inside up



FLL8 UGLJENI FILTER LONG LASTING D196 H37 (PAR) FUN 112.0185.278

- | | |
|-----------------------------|------------------|
| - Bi-Air | - Inka Lux Smart |
| - Beat XL | - Inka Plus HC |
| - Beat | - Inka Plus HCS |
| - Belle Plus | - Lithos |
| - Céline Plus | - Maxima Eco |
| - Chloè | - Maxima Touch |
| - Chloé Isola | - Pareo |
| - Chloé XL | - Soft Cube |
| - Cubia Gloss Plus | - Soft Edge |
| - Daisy Plus | - Solaris |
| - Glam-Light | - Steelmax |
| - Glam Light Zero Drip Plus | - Strip Smart |
| - Heaven 2.0 | - Strip Smart PB |
| - In-Light | - Tender |
| - Inka Lux 3.0 Premium | - Thea |
| - Inka Lux 3.0 Evo | - Thea Isola |
| | - Tweet |

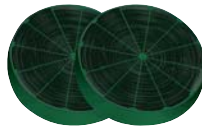

F26 UGLJENI FILTER FUN 112.0627.248

- In-Nova Zero Drip



F18-120 UGLJENI FILTER 120 CM (PAR) FUN 112.0471.609

- Heaven 2.0 Flat
- High-Light



FLL23 UGLJENI FILTER D125 FUN 112.0556.528

- | | |
|------------------|---------------|
| - Inka Smart C | - Flexa |
| - Inka Smart HCS | - Flexa Glass |
| - Inka Smart HC | |



FLL9 UGLJENI FILTER LONG LASTING EASY CUBE FUN 112.0185.276

- | | |
|-----------------------------|---------------------------|
| - Bella Comfort | - Ray |
| - Corinthia Isola | - Stilo Comfort |
| - Cubia Isola Gloss Plus | - Stilo Comfort Isola |
| - Cylindra | - Stilo Glass Smart |
| - Cylindra Isola | - Stilo Glass Smart Isola |
| - Cylindra Gloss Plus | - Stilo Smart |
| - Cylindra Isola Gloss Plus | - T-Air |
| - Eclipse | - T-Dark |
| - Glassy Isola | - T-Light |
| - In-Nova Premium | - T-Light Isola |
| - In-Nova Touch | - T-Shelf |
| - Nice | - Tratto Isola |
| - Onyx-T | |

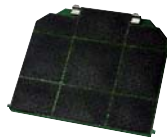

F12 UGLJENI FILTER FABULA (PAR) FUN 112.0261.258

- Fabula Plus 90



FILTERI S AKTIVNIM UGLJENOM

F23 UGLJENI FILTER D125 FUN 112.0556.527

- Inka Smart C
- Inka Smart HC
- Inka Smart HCS
- Flexa
- Flexa Glass



F24 UGLJENI FILTER NAUTILUS L FUN 112.0571.379

- 741 Base



F1 UGLJENI FILTER FUN 112.0157.238

- 1 MOTOR - 1 blower 2 MOTORA - 2 blowers
- 152 - 2740 PB

Za nape sa 2 motora potrebna su 2 filtera



F3 UGLJENI FILTER (PAR) FUN 112.0067.944

- Flexa Glass Lux
- Flexa Hip
- Value



F4-14B UGLJENI FILTER 195x139 (PAR) FUN 112.0441.093

- In-Nova Comfort
- In-Nova Smart

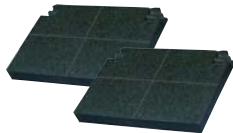

F8 UGLJENI FILTER D196 H37 (PAR) FUN 112.0157.240

- | | | |
|------------------|--------------------|------------------|
| - Agorà | - Heaven Glass 2.0 | - Strip Smart PB |
| - Bi-Air | - In-Light | - Synthesis Hip |
| - Beat XL | - Inka Lux 3.0 | - Tender |
| - Beat | Premium | - Thea |
| - Belle | - Inka Lux 3.0 Evo | - Thea Isola |
| - Belle Plus | - Inka Lux Smart | - Trendy |
| - C-Air | - Inka Plus HC | - Tweet |
| - Cèline | - Inka Plus HCS | - V-Air |
| - Cèline Plus | - K-Air | - West |
| - Chloè | - Lithos | - Veil |
| - Chloè Isola | - Maxima Eco | - Zoom Plus |
| - Chloè XL | - Maxima Touch | - 106/35 Plus |
| - Cocktail | - Odette | |
| - Cubia Plus | - Odette Plus | |
| - Daisy Plus | - Onyx-C | |
| - Glam-Light | - Onyx-V | |
| - Glam Light | - Pareo | |
| - Zero Drip Plus | - Ranch | |
| - Glow | - Soft Cube | |
| - Glow Plus | - Soft Edge | |
| - Grèxia | - Solaris | |
| - Heaven 2.0 | - Steelmax | |
| - Heaven Air | - Strip Smart | |

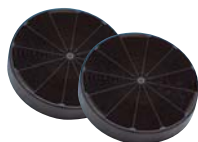

F9 UGLJENI FILTER FUN 112.0157.243

- | | |
|-----------------------------|---------------------------|
| - Air Hub Glass | - Stilo Angolo |
| - Bella Comfort | - Stilo Comfort |
| - Corinthia Isola | - Stilo Comfort Isola |
| - Cubia Isola Plus | - Stilo Glass Smart |
| - Cubia Isola Gloss Plus | - Stilo Glass Smart Isola |
| - Cylindra | - Stilo Smart |
| - Cylindra Isola | - T-Air |
| - Cylindra Gloss Plus | - T-Dark |
| - Cylindra Isola Gloss Plus | - T-Light |
| - Eclipse | - T-Light Isola |
| - Glassy Isola | - T-Shelf |
| - In-Nova Air | - Tratto Isola |
| - In-Nova Premium | |
| - In-Nova Touch | |
| - In-Nova Zero Drip | |
| - Nice | |
| - Onyx-T | |
| - Ray | |



F16 UGLJENI FILTER (PAR) FUN 112.0459.452

- Luft



F21 UGLJENI FILTER (PAR) FUN 112.0506.172

- Ilma
- Ilma Touch



F22 UGLJENI FILTER NAUTILUS FUN 112.0540.783

- Glam-Fit
- Pyana
- Soft Slim
- Talika
- V-Air Flat



UGLJENI FILTER VRT, TSPG, TGL, TSP FUN 112.0569.559

- | | |
|-------|--------|
| - TGL | - TSPG |
| - TSP | - VRT |

F2 UGLJENI FILTER (PAR) FUN 112.0157.241

- Omnia



UGLJENI FILTER TLSC FUN 112.0569.558

- TLSC



ODVODNI ELEMENTI Ø 100 mm

NEPOVRATNI VENTIL D100 FUN 112.0572.297

Nepovratni ventil okrugli



ODVODNI ELEMENTI Ø 120 mm

CIJEV TR 1500 FUN 112.0157.294

Pravokutna cijev
TR 1500
220x55x1500 mm

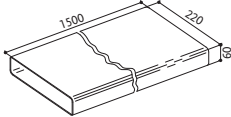

SPOJNICA RRC FUN 112.0157.296

Koljeno
pravokutno/okruglo

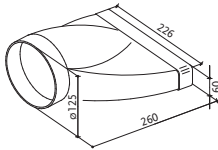

KOLJENO CRCV 90 REVERZIBILNO FUN 112.0157.298

Koljeno
okruglo/pravokutno
90° reverzibilno

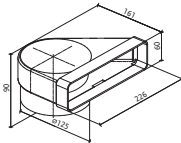

KOLJENO CRO 90 FUN 112.0157.300

Koljeno pravokutno/
pravokutno 90°
horizontalna

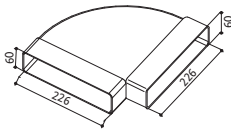

REDUKCIJA RC 125-100 FUN 112.0157.302

Redukcija 125-100/
okrugla

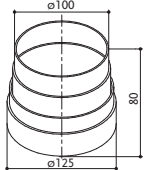

ROZETA GRE FUN 112.0157.304

Pravokutna rozeta
vanjska

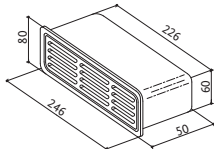

KOLJENO CRCO 90 REVERZIBILNO FUN 112.0157.306

Koljeno
pravokutno/
okrugla 90°
horizontalno
reverzibilno

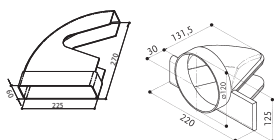

SPOJNICA RCR FUN 112.0157.295

Spojnicna cijevi

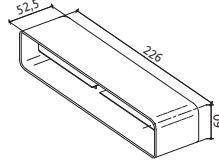

SPOJNICA RPR FUN 112.0157.297

Zidna spojnicna -
pravokutna

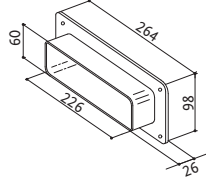

KOLJENO CRV 90 FUN 112.0157.299

Koljeno
pravokutno/
pravokutno 90°

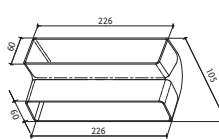

FLEKSIBILNO CRIJEVO TCF 130 FUN 112.0157.301

Fleksibilno crijevo
L = 1,5 m Ø 130 mm

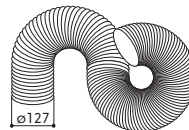

ROZETA GDC 125 FUN 112.0157.303

Rozeta okrugla vanjska

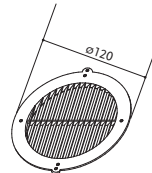

NOSAČ CIJEVI FRF FUN 112.0157.305

Nosač za cijev

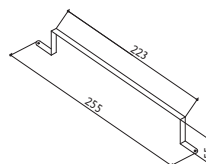

KOLJENO CC 90 FUN 112.0157.307

Koljeno okruglo 90°
Ø 125 mm

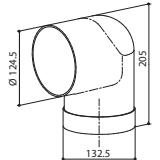

CIJEV TC 1000 FUN 112.0157.308

Cijev okrugla TC 1000

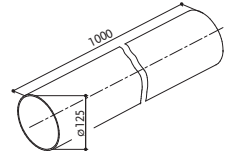

SPOJNICA 2 FR FUN 112.0157.309

Završnica okrugla

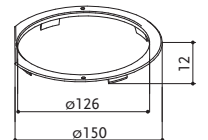

VENTIL VR2 120 FUN 112.0189.216

Nepovratni ventil
okrugli



OBUJMICA 2FCR FUN 112.0169.119

Obujmica za spajanje cijevi

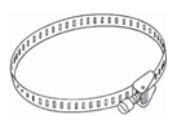

SPOJNICA RR 90/55

6098004
Spojna redukcija
pravokutno/pravokutno
90/55 DX

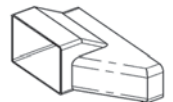

6098015
Spojna redukcija pravokutno/pravokutno 90/55 LX

NEPOVRATNI VENTIL D120 FUN 112.0189.207

Nepovratni ventil



ODVODNI ELEMENTI Ø 125 mm

NEPOVRATNI VENTIL 3D D125 FUN 112.0569.782

Nepovratni ventil okrugli



HERMETIČKI KANALNI VENTIL D125 FUN 112.0569.784

Hermetički kanalni ventil



ODVODNI ELEMENTI Ø 150 mm

CIJEV D150 1000 FUN 112.0253.681

Cijev okrugla TC 1000
Ø 150 mm

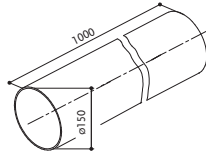

CIJEV TCF 150 L=1,5 M. FUN 112.0280.687

Fleksibilno crijevo
L = 1,5 m Ø 150 mm

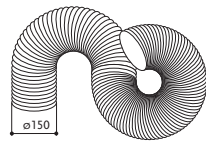

OKRUGLA SPOJNICA D150 FUN 112.0253.690

Okrugla spojnica
Ø 150 mm

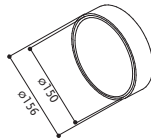

SPOJNICA RCR 220x90 FUN 112.0459.428

Spojnica pravokutna
220x90 mm

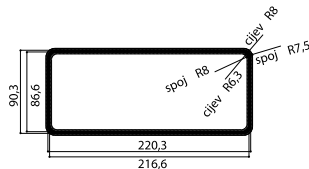

KOLJENO 90° D150 FUN 112.0253.688

Koljeno okruglo 90°
Ø 150 mm

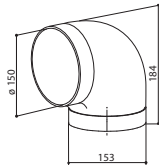

CIJEV TR 1200 220x90 FUN 112.0459.427

Cijev pravokutna
TR 1200
220x90 mm

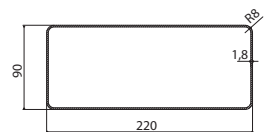

SPOJNICA RRC 220x90 FUN 112.0459.429

Spojnica
okruglo/pravokutno
220x90 mm

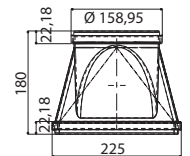

KOLJENO CRV 90 220x90 FUN 112.0459.453

Koljeno
okruglo/
pravokutno 90°
220x90 mm

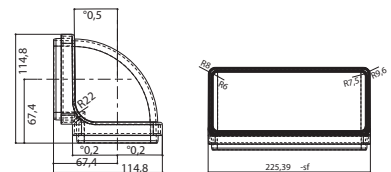

KOLJENO CRC 90 220x90 FUN 112.0459.451

Koljeno
okruglo/pravokutno
90°
220x90 mm

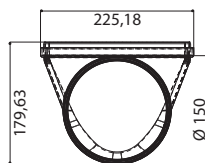

NOSAČ CIJEVI FRF 220x90 FUN 112.0459.456

Nosač za cijev
220x90 mm



KOLJENO CRO 90 220x90 FUN 112.0459.455

Koljeno
pravokutno/
pravokutno 90°
horizontalna
220x90 mm

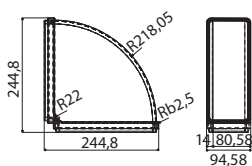

FLEKSIBILNA SPOJNICA RF 600 FUN 112.0280.685

Pravokutna fleksibilna
spojnica

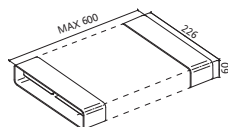

NEPOVRATNI VENTIL 3D D150 FUN 112.0569.781

Nepovratni ventil



VENTIL D150 FUN 112.0086.450

Ventil



HERMETIČKI KANALNI VENTIL D150 FUN 112.0569.783

Hermetički kanalni ventil



UGRADNJA

Pravilna ugradnja započinje izvidom. Pri odabiru morate znati:

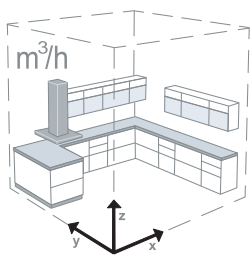

Zapreminu kuhinje (o kojoj ovisi potreban kapacitet nape).
Pogledati odjeljak "Odaberite odgovarajuću napu".

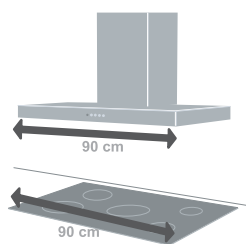

Duljinu ploče za kuhanje (napa bi, u pravilu, trebala biti dugačka barem koliko i ploča za kuhanje).

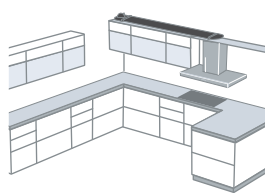

Pozicija i udaljenost otvora odvoda od ploče za kuhanje (vrlo duge cijevi i velik broj koljena bitno ograničavaju učinkovitost nape).

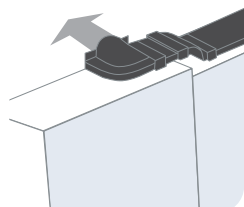
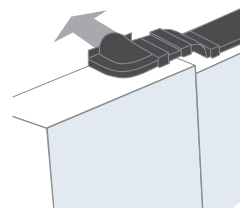

Po standardu potrebna su dva otvora na vanjskom zidu, uz odgovarajuću opremu:

1. ulazni otvor za prozračivanje prostorije izvana, načinjen na nižem dijelu zida.
2. izlazni otvor za izbacivanje dima iz prostorije, načinjen na višem dijelu zida (ili u dimnjaku predviđenom isključivo u ovu svrhu).

Kod usisne verzije nape, izlazni otvor služi kao krajnji vod sustava izbacivanja zraka.

Ispravnost proizvoda

- Nakon otvaranja, provjerite ispravnost uređaja.
- Provjerite je li uređaj kompletan i neoštećen prilikom transporta.
- Uređaj mora biti dostavljen s jamstvom ili uputama za uporabu.

NAPOMENA: Ne montirajte oštećeni uređaj. Oštećeni uređaj zamijenite bez naknade. U protivnom, morat ćete snositi troškove servisiranja. Prije montaže nemojte skidati zaštitnu foliju.

Udaljenost nape od ploče za kuhanje

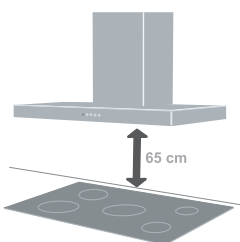

Za učinkovitiji rad nape, savjetujemo ugradnju na visini koja ne prelazi 75 cm iznad ploče za kuhanje. Najmanja udaljenost od ploče za kuhanje iznosi 65 cm.

NAPOMENA: jamstvo ne pokriva eventualne štete nastale uslijed nepoštivanja najmanje sigurnosne udaljenosti. Odvod kuhinjskih para mora biti što je moguće bliže napi i preporučuje se odvodni kanal promjera 15 cm (nikako manje od 12 cm), za dužine koje ne prelaze 3-4 m uz najviše 2 koljena.

Neke nape koje se montiraju vertikalno (Mirror, Matrix) potrebno je instalirati niže. Provjerite tehničku dokumentaciju proizvoda.

Provjera

- 1 - Uključite motor uređaja
- 2 - Uključite rasvjetu

Kod ekstrakcijske verzije nape, provjerite je li pravilno spojena na izlazni sustav cijevi. Kod filtracijske verzije nape, provjerite jesu li postavljeni filteri s aktivnim ugljenom.

Prvo čišćenje

- Skinite zaštitnu foliju
 - Uklonite nečistoće pomoću vlažne spužve i malo neutralnog sredstva za čišćenje
 - Isperite vlažnom krpom
 - Posušite mekanom krpom.
- Ukoliko je napa izrađena od nehrđajućeg čelika, potrebno ju je ispolirati. Napu od nehrđajućeg čelika možete zaštititi uporabom Faber Clin&Clin maramica



Faber nape jednostavno je instalirati zahvaljujući sistemu EASY CUBE:

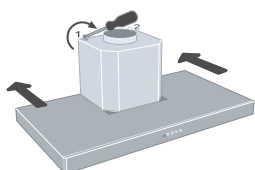

Objesite napu na nosač

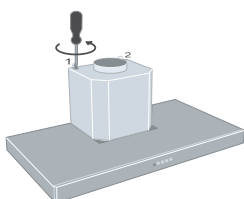

Nivelirajte napu

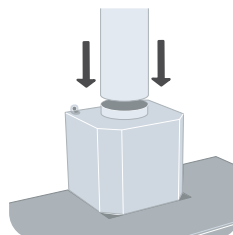

Spojite odvodne cijevi

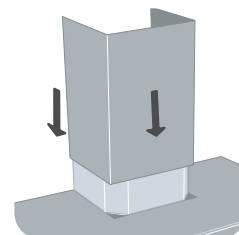

Montirajte ukrasni dimnjak

KORIŠTENJE I ODRŽAVANJE

KORIŠTENJE I ODRŽAVANJE

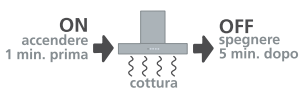

Uključenje nape minutu prije kuhanja pokreće protok zraka koji usmjerava mirise i paru prema usisnoj površini. Ukoliko je potrebno, ostavite napu uključenom i nakon završetka kuhanja, kako bi se u potpunosti otklonili svi mirisi i para.

- Metalne filtere za masnoću operite ručno ili u perilici posuđa svaka dva mjeseca
- Sintetičke filtere za masnoću zamijenite svaka dva mjeseca
- Ugljene filtere za uklanjanje neugodnih mirisa zamijenite svaka tri mjeseca¹ (vrijedi za filtracijske nape)
Pravilno održavanje filtera jamči bolju efikasnost uređaja.

NAPOMENA: masnoća nataložena na filteru je zapaljiva: održavanje filtera potrebno je izvršiti na ispravan način.

¹ Ovi vremenski intervali odnose se na normalnu uporabu nape od približno 3 sata na dan.

Čišćenje nape

- Uklonite nečistoće pomoću vlažne spužve i malo neutralnog sredstva za čišćenje²

- Isperite vlažnom krpom

- Posušite napu mekanom krpom. Ukoliko je napa izrađena od nehrđajućeg čelika, nanesite polituru. Unutrašnji vod očistite jednom godišnje.

²Sredstva za čišćenje na bazi kiseline ili kloru mogu oštetiti površinu uređaja.

FILTERI PROTIV NEUGODNIH MIRISA

Long lasting filter

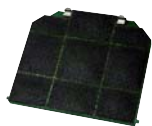

3
GODINE
MAKSIMALNO

Faber je razvio novi, obnovljivi filter sa aktivnim ugljenom. Zahvaljujući tehnologiji više slojeva, Long Lasting filter dodatno poboljšava učinkovitost filtracije, tako da prvi sloj zadržava krupnije čestice nečistoće, a drugi gušći sloj filtrira ostatak i jamči optimalnu čistoću zraka.

Filter je moguće oprati u perilici posuđa svaka 2 do 3 mjeseca, kroz period od maksimalno 3 godine. Suši se na sobnoj temperaturi u vertikalnom položaju kako bi se voda mogla iscijediti iz filtera. Alternativno, možete ga sušiti u pećnici na temperaturi od 50° C.¹

¹ Odnosi se na normalnu uporabu nape od približno 3 sata na dan.

High performance

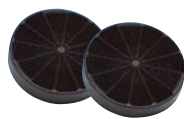

6
MJESECI
MAKSIMALNO

Visokoučinkoviti filteri sa izuzetno gustom strukturom mikrogranula ugljena koji jamči do 80% filtracije ulaznih plinova i trajnost do 6 mjeseci, što je duplo više nego klasični ugljeni filter, te ušteda za više od 20%.

Keramički filter



Inovativan ugljeni filter koji se može regenerirati u peći na 200°C svaka 2-3 mjeseca i omogućava postizanje visoke učinkovitosti apsorpcije.

CLIN & CLIN LINIJA ZA ČIŠĆENJE

Clin&Clin revitalizirajuća pasta



Uklanja mrlje, točkice i male fleke hrđe uzrokovane svakodnevnom uporabom te vraća čeliku prirodan sjaj.

Clin&Clin zaštitne maramice



Štite i održavaju ljepotu površina izrađenih od čelika. Preklične i jednostavne. Za uporabu na čistoj i suhoj površini.

SIGURNOST I LEGENDA POJMOVA

KVALITETA I SIGURNOST

Faber nape plod su 60 godina iskustva na području pročišćavanja kuhinjskog zraka

- Faber je prva tvrtka na području kuhinjskih napa s certifikatom za sustav upravljanja kvalitetom ISO 9001.
- Certifikatom sustava za integraciju kvalitete, sigurnosti i upravljanja okolišem ustanovljenim od strane SGS grupe sukladno standardu ISO 9001:2000, OHSAS 18001 i ISO 14001 standardnim normama.
- Također smo kao prva tvrtka u svijetu, primili SGS Excellence Certifikat broj 001.
- Sve Faber nape sukladne su Europskom sigurnosnom standardu (oznaka sukladnosti CE), a također su odobrene i od strane IMQ, pouzdane, neovisne organizacije koja kupcima dodatno jamči kvalitetu proizvoda (oznaka sigurnosti IMQ)

FABER NAPE DIZAJNIRANE SU ZA SIGURNOST

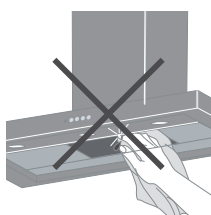

Posebno obrađeni unutarnji rubovi i temperirano staklo sprječavaju porezotine i slične ozljede.

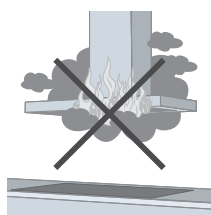

Termo zaštićeni motori i nezapaljiva plastika smanjuju rizik od požara. Elektronički sklopovi su kompaktni, a kablovi i ožičenje su brižljivo smješteni u kućištu kako bi se spriječili strujni udari i opasno iskrenje.

Sve Faber nape su prošle kontrolu sigurnosti i zvedbe. Usisni kapacitet i jačina buke ispitani su u skladu sa standardnim normama:

- EN 61591
- EN 60704-3

jedinstvenim specifikacijama za praćenje izvedbe kuhinjske nape.

NAPOMENA: uspoređivanje uređaja različitih proizvođača potrebno je izvesti na temelju svih podataka dobivenih u skladu s ovim standardima. Ispitni laboratorij tvrtke Faber posjeduje certifikat NEMKO i IMQ.

LEGENDA POJMOVA

ZAVRŠNA OBRADA / BOJA

| | |
|---------------|---|
| AM/X | aluminij/maska nehrđajući čelik |
| BK | crna |
| BK GLASS/A | crno staklo/aluminij |
| BK GLOSS | crna sjajna |
| Burgundy/Gold | bordo/zlatna |
| CG | country siva |
| CI | lijevano željezo |
| CT | efekt križanog titanijskog |
| DB | prašnjavo plava |
| DG | tamno siva |
| DG/C | tamno siva/beton |
| DGC | tamno sivi beton |
| LG | svijetlo siva |
| LG/X | svijetlo siva/ručka od nehrđajućeg čelika |
| OB | stari mesing |
| OC | stari bakar |
| OM | kositar |
| SS | crno tijelo/linija od nehrđajućeg čelika |
| WG | almond (boja badema, topla siva) |
| WH | bijela |
| WH MATT/TS | bijela mat/tibetansko srebrna |
| WW | topla bijela |
| X | nehrrđajući čelik |
| X/OM | nehrrđajući čelik/kositar |
| X/V | nehrrđajući čelik/staklo |

PERFORMANSE

M³/H Kapacitet usisa zraka (IEC)

W Snaga (W)

↔ Širina nape

| | |
|-----------|---------------------------------|
| 16 | 1 motor , širina 600 mm. |
| 18 | 1 motor , širina 800 mm. |
| 19 | 1 motor , širina 900 mm. |

Podaci o izvedbi iskazani u ovom katalogu mjereni su prema novom kodeksu, koji su potpisali najkvalificiraniji europski proizvođači udruženi u CECED (Europsko udruženje proizvođača domaće i profesionalne opreme).

To je strogi kodeks određen radi transparentnosti podataka kapaciteta i buke napa, mjernih pravila zajedničkih svim proizvođačima:

- sposobnost usisavanja prema IEC / EN 61591 standardu (napa s odvodom zraka)
- razina buke u skladu s IEC / EN 60704-3 standardom

SPECIJALNA ZAVRŠNA OBRADA

Fotografije su ilustrativnog karaktera i ne prikazuju u potpunosti realan izgled završne obrade.



Crna sjajna



Crna mat RAL 9005



Bijela mat NCS S 500N



Bijela

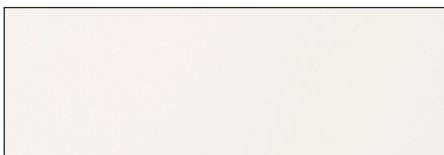

Topla bijela



Siva mat



Bordo/Zlatna RAL 020 30 30



Tamno siva mat RAL 0003000



Country siva mat



Lijeвано željezo



Kositar (stari metal)

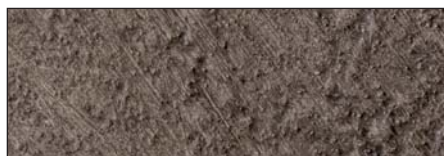

Tamno sivi beton



Efekt križanog titanija



Tamni kamen



Svijetli kamen



Zlatna



Stari mesing RAL 8025



Stari bakar

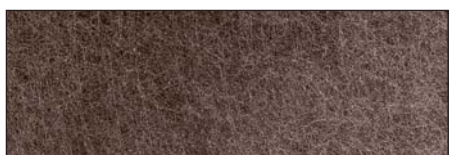

Tibetansko srebrna

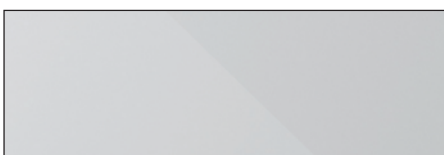

Bijela/Topla siva 3C - WH/WG

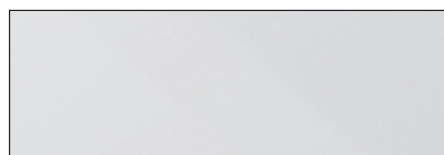

Bijela/Transparentna - WH/T



Topla siva 1C/Topla siva 3C - WG1C/WG3C



Tamno sivo/Svijetlo sivo staklo - DG/LG



Prašnjavo plava RAL 240 60 15



Boja pijeska RAL 0508010

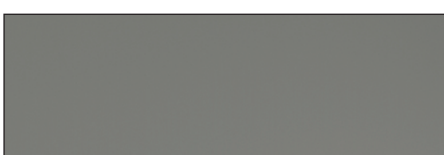

Titanij mat RAL 7048

PODRŠKA I SERVIS

Centralni servis
u Hrvatskoj
Gemma B&D
10000 Zagreb,
Prisavlje 2

+385 1 6195 582

Tehnička služba
u Bosni i Hercegovini
Gemma BH
71000 Sarajevo,
Džemala Bijedića 25c

+387 33 407 937

Faber tehničko servisna podrška je aktivna diljem Europe

Brojeve telefona potražite na www.faberspa.com

Svi Faber proizvodi podliježu 2-godišnjem "Full guarantee" jamstvu

"Full guarantee" pokriva sve nedostatke na proizvodu koji bi bili posljedica tvorničkih grešaka i kvarova nastalih u jamstvenom roku, pri normalnoj upotrebi proizvoda uz poštivanje svih tehničkih naputaka.

Ovo jamstvo ne obuhvaća oštećenja ili kvarove nastale kao posljedica nepridržavanja priloženih uputstava za rukovanje, nepravilnog priključivanja, kvarove nastale nepravilnim rukovanjem, mehanička oštećenja nastala prilikom pada ili uporabom sile, oštećenja koja je prouzročila nestručna osoba ili neovlašteni servis ili ugrađivanje neoriginalnih rezervnih dijelova, oštećenja nastala uslijed udara groma ili prenapona.

Radi zadovoljstva naših kupaca i radi njihovog povjerenja, uveli smo produženo, petogodišnje jamstvo na Faber nape u Hrvatskoj, Mađarskoj, Bosni i Hercegovini te Crnoj Gori.

"Full guarantee" pokriva sve nedostatke na proizvodu koji bi bili posljedica tvorničkih grešaka i kvarova nastalih u jamstvenom roku, pri normalnoj upotrebi proizvoda uz poštivanje svih tehničkih naputaka.

Ovo jamstvo ne obuhvaća oštećenja ili kvarove nastale kao posljedica nepridržavanja priloženih uputstava za rukovanje, nepravilnog priključivanja, kvarove nastale nepravilnim rukovanjem, mehanička oštećenja nastala prilikom pada ili uporabom sile, oštećenja koja je prouzročila nestručna osoba ili neovlašteni servis ili ugrađivanje neoriginalnih rezervnih dijelova, oštećenja nastala uslijed udara groma ili prenapona.



BILJEŠKE

GEMMA GROUP

BOSNA I HERCEGOVINA / Gemma BH d.o.o.

71000 Sarajevo, Džemala Bijedića 25c
tel./fax: 00387 33 407 935, 00387 33 407 936
e-mail: info@gemma.ba
www.gemma.ba

HRVATSKA, CRNA GORA / Gemma B&D d.o.o.

10000 Zagreb, Prisavlje 2 (Bočarski dom)
tel.: 00385 1 6196 446, 6195 604, fax: 00385 1 6195 581,
e-mail: veleprodaja@gemma.hr
www.gemma.hr

MAĐARSKA / GEMMA B&D Kft.

2040 Budaörs, Puskás Tivadar út 1
Tel.: 0036 23 769 245
e-mail: info@gemmabd.hu
www.gemmabd.hu

SRBIJA / Gemma B&D d.o.o.

11070 Novi Beograd, Đorđa Stanojevića 14
Veleprodaja: tel: 00381 11 2285 020, fax: 00381 11 3188 033
e-mail: info@gemma.rs
www.gemma.rs



EKSKLUZIVNI ZASTUPNIK

GEMMA B&D

BOSNA I HERCEGOVINA / Gemma BH d.o.o.
71000 Sarajevo, Džemala Bijedića 25c
tel./fax: 00387 33 407 935, 00387 33 407 936
e-mail: info@gemma.ba
www.gemma.ba

HRVATSKA, CRNA GORA / Gemma B&D d.o.o.
10000 Zagreb, Prisavlje 2 (Boćarski dom)
tel.: 00385 1 6196 446, 6195 604, fax: 00385 1 6195 581
e-mail: veleprodaja@gemma.hr
www.gemma.hr

FABER
FRANKE'S AIR EXPERT

FABER SpA
Viale XIII Luglio, 160
60044 Fabriano (AN), Italy

tel.: 0039 0732 6911
fax: 0039 0732 691233
e-mail: info@faberspa.com

www.faberspa.com/hr

